



# Utilizzo di coltelli



# La mano



**E voi?**

Chi di voi ha già subito una lesione da taglio?

# Evitare le lesioni da taglio

## Scelta del coltello giusto

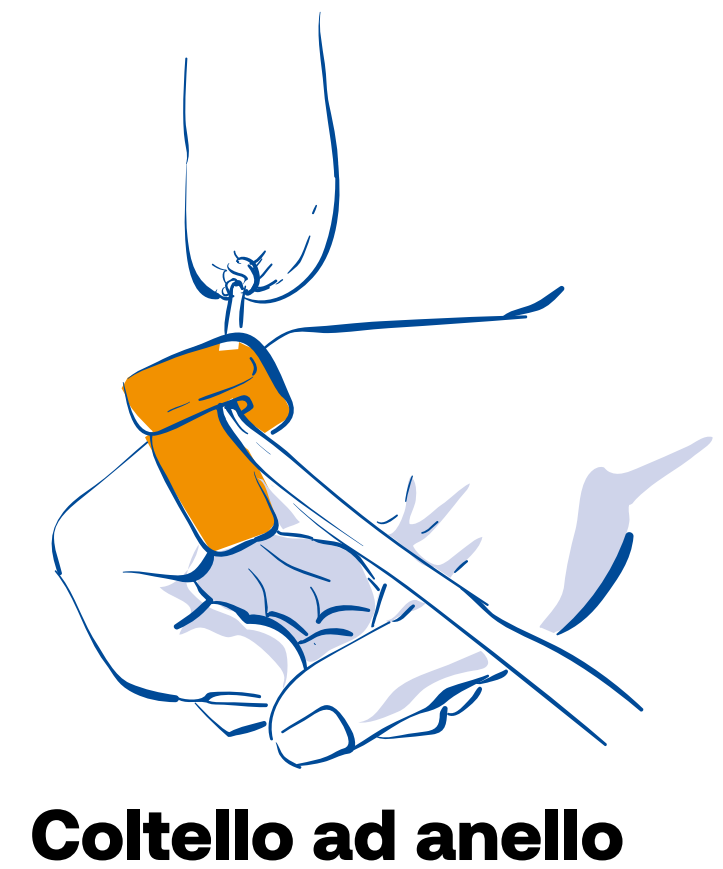
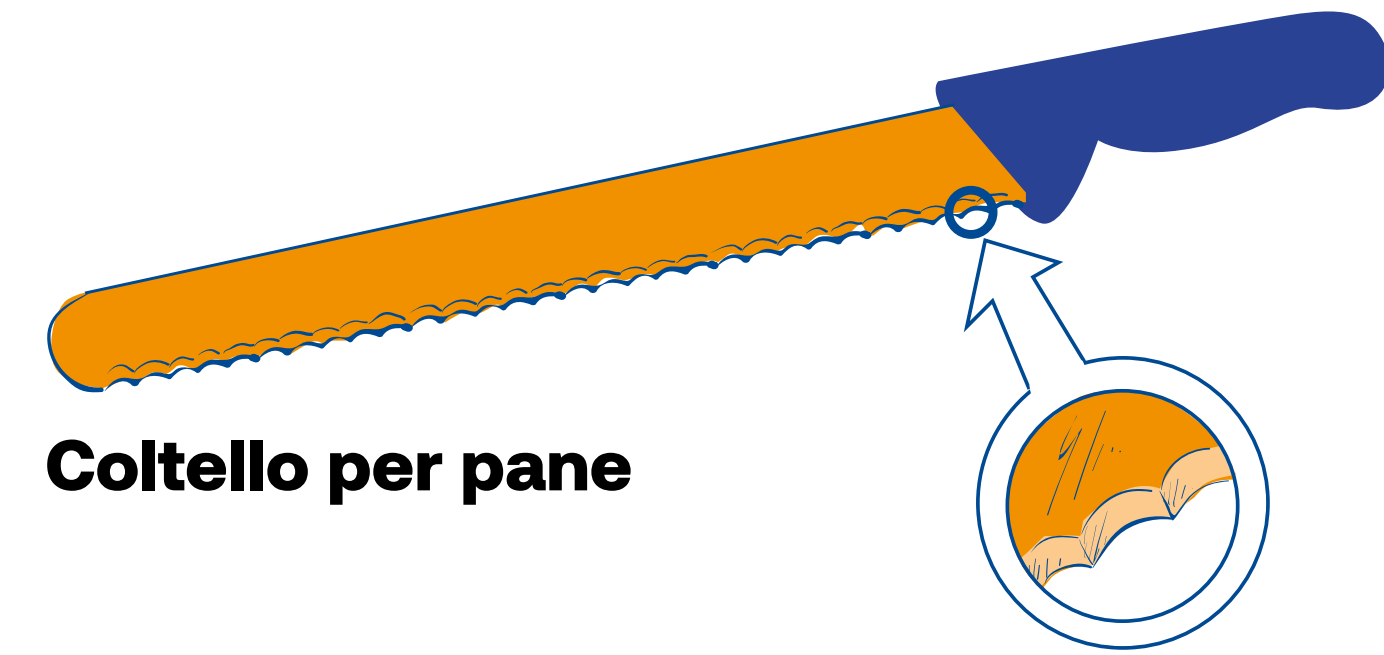
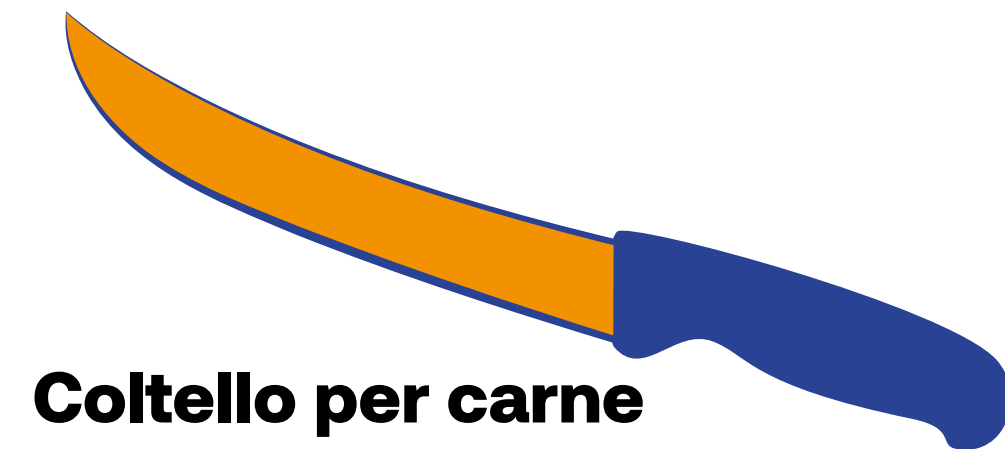

# Prevenire le lesioni da taglio



## **Tecnica di taglio corretta**

Presenza ad artiglio



Lavorare su un piano resistente  
o su un tagliere

# Prevenire le lesioni da taglio



## **Corretto grado di affilatura**

Un coltello è affilato quando permette di tagliare un pomodoro senza dovervi applicare forza.

# Prevenire le lesioni da taglio



## **Affilatura dei coltelli**

...con affilatrice:  
indossare occhiali protettivi, protezioni  
per l'udito



...a mano:  
indossare guanti protettivi

# Prevenire le lesioni da taglio

## Con coltelli in perfette condizioni

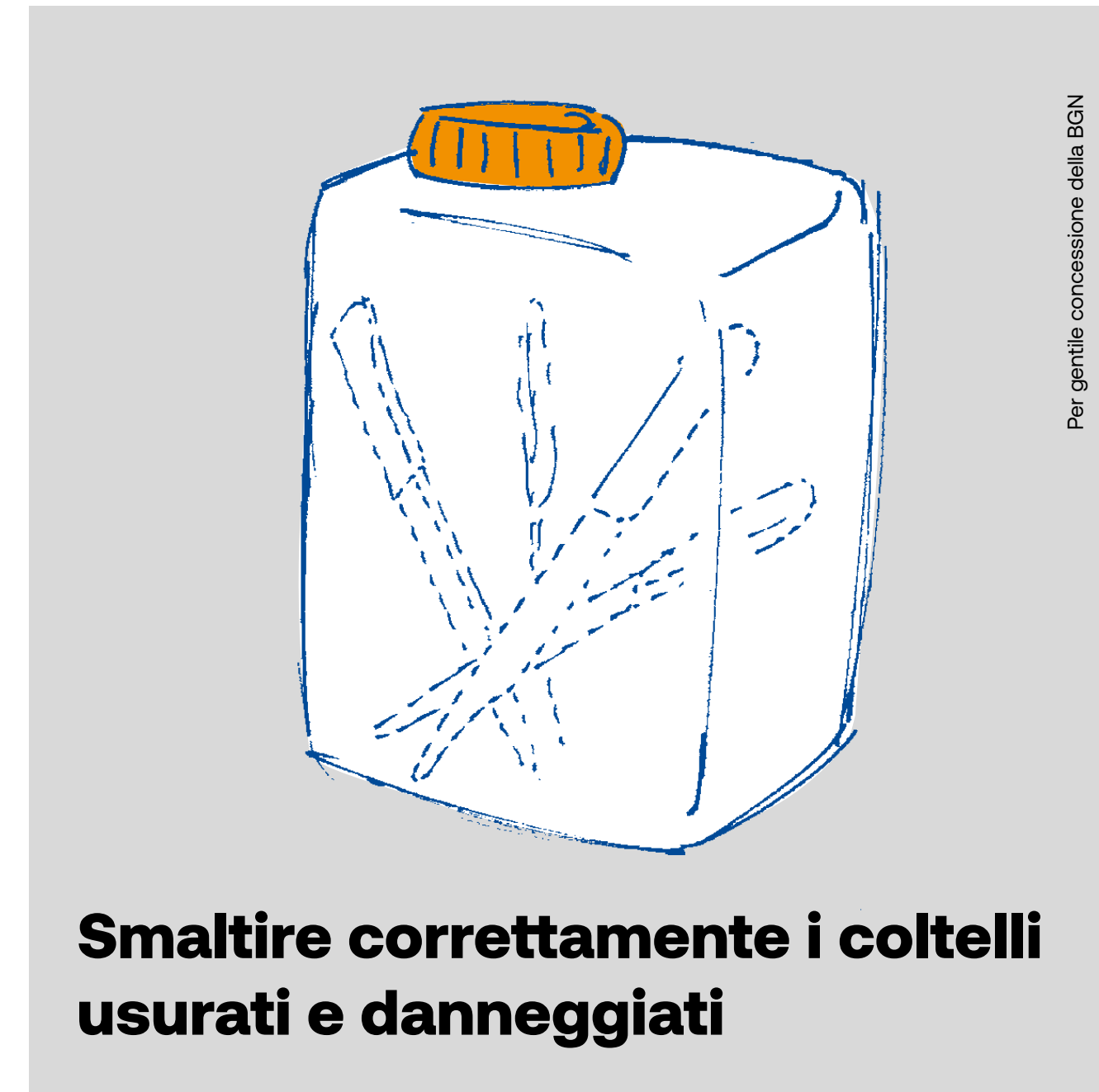

# Prevenire le lesioni da taglio

## Stoccaggio e trasporto corretto di coltelli



**Cesto per coltelli**

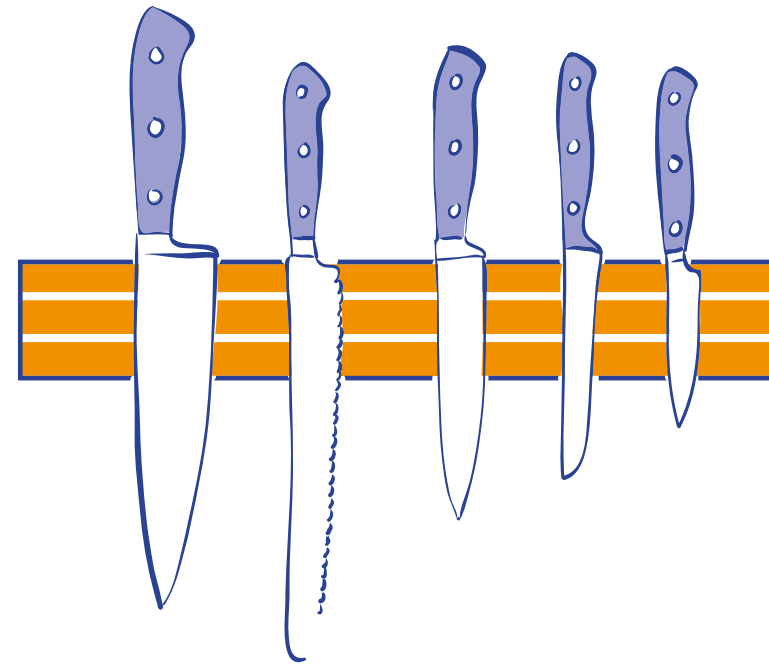

**Barra per coltelli**

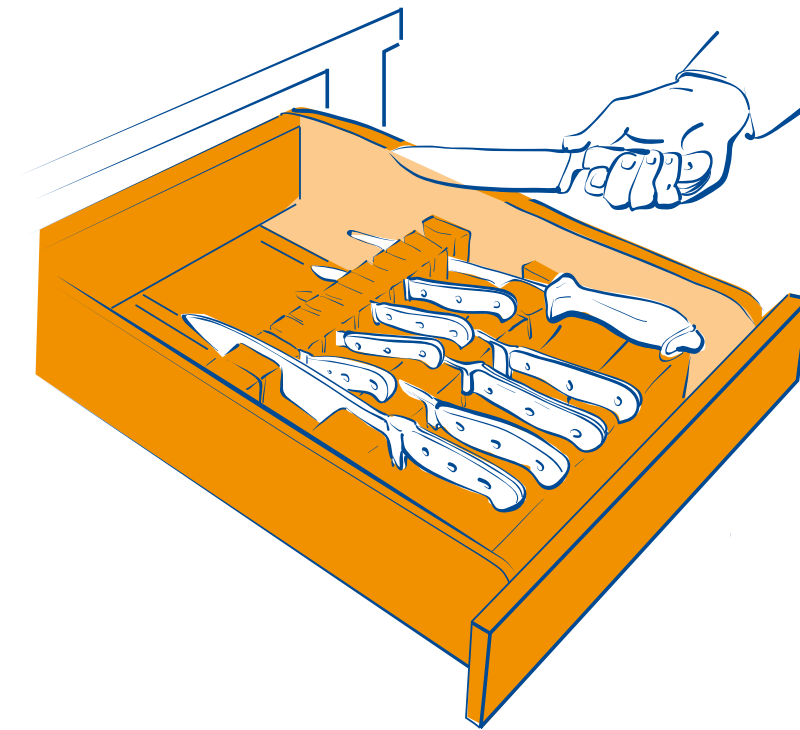

**Cassetto con alloggiamenti**

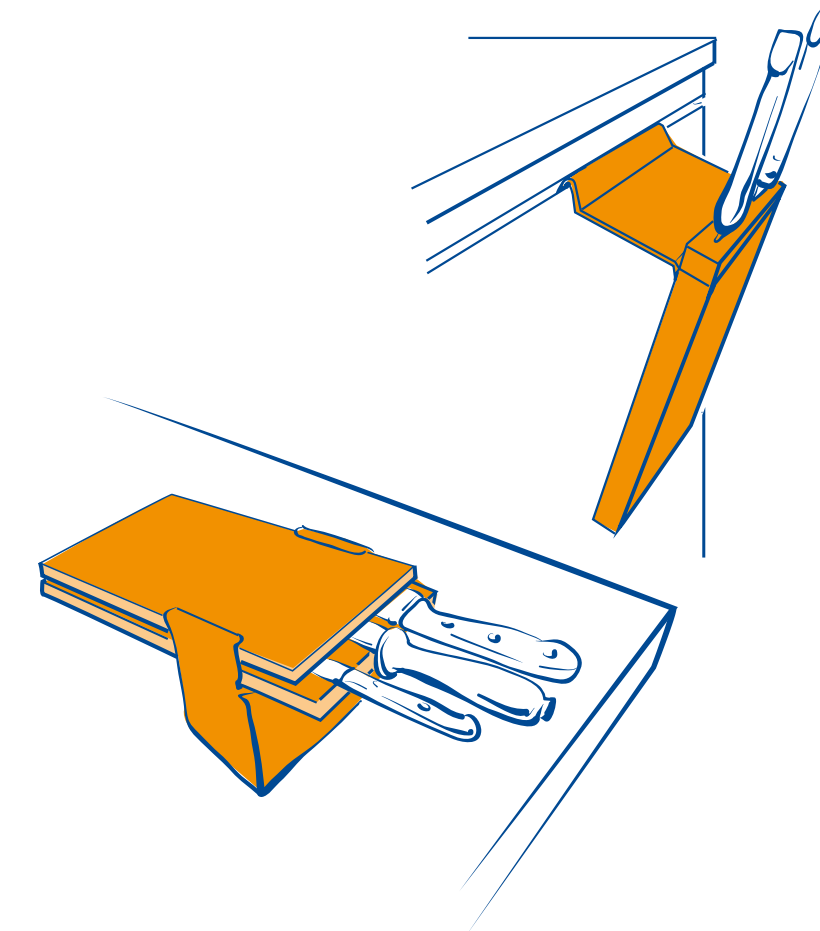

**Portacoltelli da tavolo**

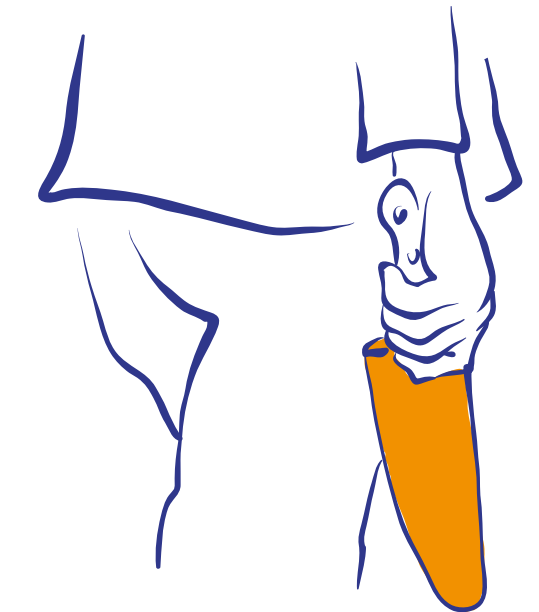

**Come trasportare un coltello**

# Prevenire le lesioni da taglio



## **Lavaggio dei coltelli**

Non lasciarli sparsi nel lavello



In appositi contenitori

# Prevenire le lesioni da taglio



**Indossare dispositivi  
di protezione  
individuale adeguati**

## E in pratica?

Come è possibile evitare  
lesioni da perforazione e da  
tagli nella nostra azienda?

Cosa potete cambiare e migliorare nel vostro modo di lavorare?

Cosa possiamo cambiare e migliorare in azienda?



[safeatwork.ch](https://www.safeatwork.ch)



Schweizerische Eidgenossenschaft  
Confédération suisse  
Confederazione Svizzera  
Confederaziun svizra

Finanziato dalla CFSL  
[www.cfsl.ch](https://www.cfsl.ch)