

Questo disegno e' di proprieta' di OIOLI Rubinerie che, a norma di legge, si riserva tutti i diritti.
 This drawing / specification is the property of OIOLI Rubinerie and must not be copied in part or whole without prior written permission of OIOLI Rubinerie.

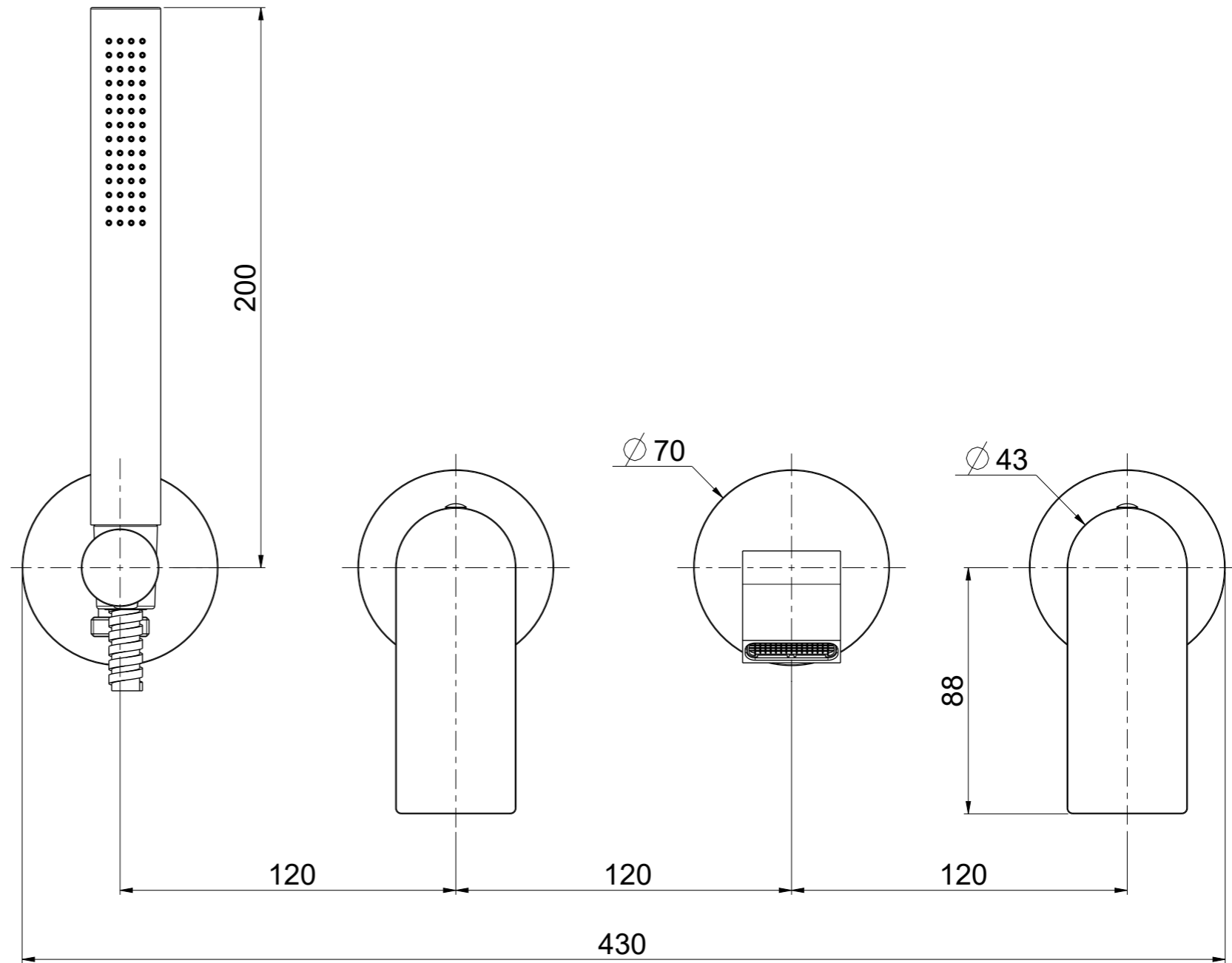
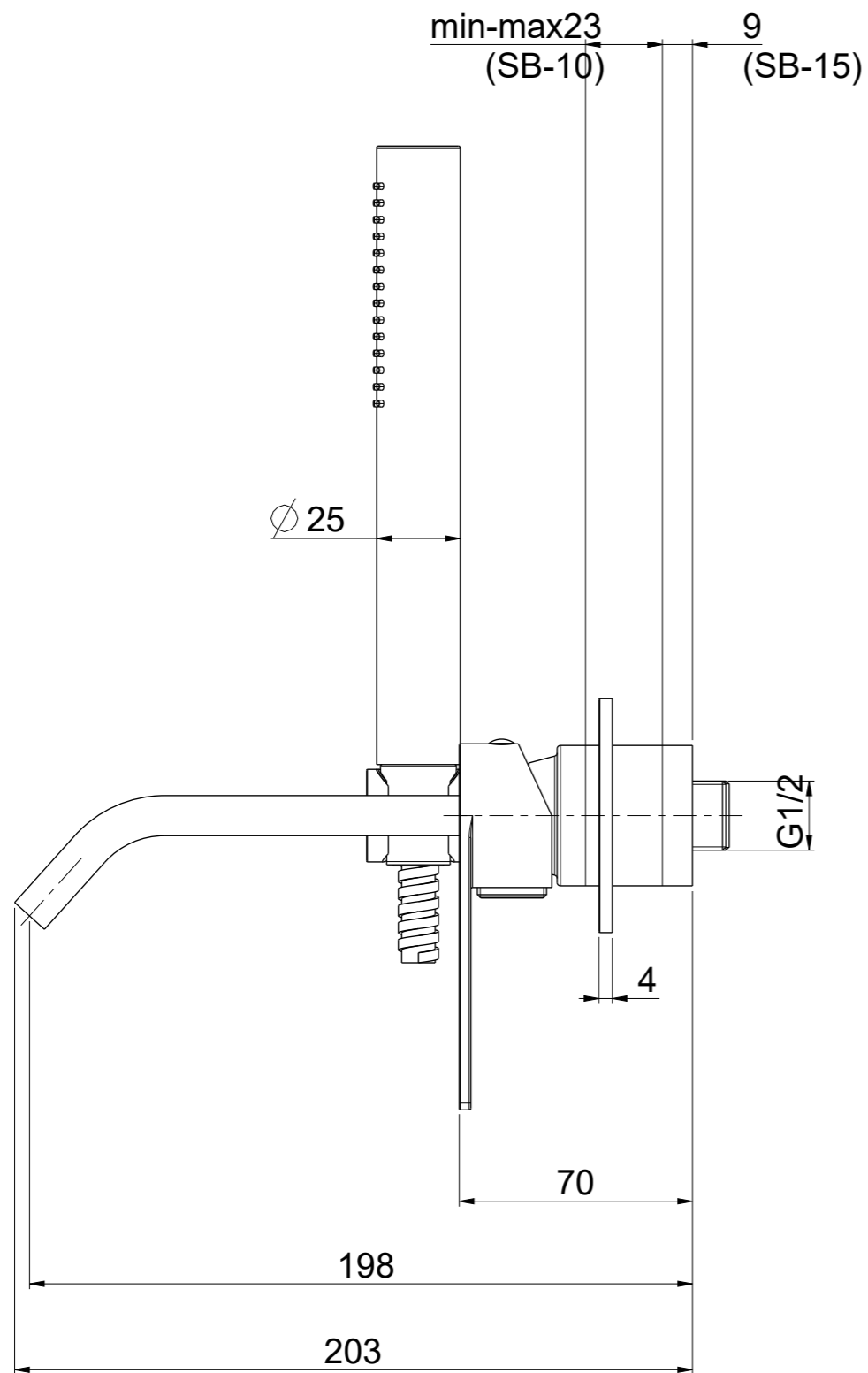

OIOLI
RUBINETTERIE
 e-mail: mattia@oioli.com
 Via Pul Stretta, 10/12 Tel. 0322 956338
 28024 Gozzano (No) Fax 0322 912094
 ITALY

DATA	2/2/2024	VERSIONE	PROGETTO	SCALA	CODICE DISEGNO	
DISEGNATORE	B.E.	1.1		1:2	OITIEV109RO	
DESCRIZIONE	PARTI ESTERNE VASCA A PARETE C/SUPPORTO TIKI					ARTICOLO
						TIEV109RO