

Mamiya M645 1000 S

Instructions



The Mamiya M645 1000S is a new improved model of the M645, a camera widely acclaimed for bridging the gap between small and large format cameras by introducing the medium format, the purpose of which is to offer the world of larger-negative quality to camera users who are accustomed to the handling ease and compactness of 35mm SLR's.

Every care has been taken to assure that your Mamiya M645 1000s will provide you with years of trouble-free service. However, to avoid possible mishandling, be sure to carefully read this instruction manual before using your new camera.

CONTENTS

Special Features of the Mamiya M645 1000s	3	Using the Waist-Level Finder S	44
Specifications	5	The Mamiya Moving Coil Electronic Shutter.	47
Names and Functions of Parts.....	7	Depth-of-Field	48
Testing to See if the Camera Functions Properly	16	Using Flash	49
Interchanging Lenses	17	Multiple-Exposures	50
Interchanging Finders	18	Infrared Photography	50
Focusing Screens	20	Mirror Lock-up	51
Inserting a Battery	21	Using the Delayed Shutter Release	52
Battery Check	22	Interchanging the Film Advance Crank	53
Film Loading	23	Tripod Socket	55
Film advancing	27	Time Exposures	55
Shutter Speed Dial	27		
Aperture Ring/Stop-down Operation	28	Trouble-Shooting	56
Focusing	29	Precautions	57
Shutter Release and Film Transport Mechanism	30	Care of the Camera	58
Unloading Film	31		
The Neck Strap	32	Mamiya-Sekor C Lenses	59
Holding the Camera	32	Depth-of-Field Table	62
Using the PD Prism Finder S.....	35	Accessories	63
Using the CdS Prism Finder	39		

Special Features of the Mamiya M645 1000S

The Mamiya M645 is a 6 x 4.5cm large-negative SLR that is both extremely versatile and compact.

1. Large-Negative Quality

The 6 x 4.5cm format offers approximately 3 times more area than the 35mm format. Moreover, unlike the 6 x 6cm square negative, there is little waste of the negative area. For beautiful color enlargements everytime, the 6 x 4.5cm format is the ideal format.

2. Compact Design

Despite the large-negative it produces, the Mamiya M645 is designed to handle as easily as a 35mm SLR. Its compact size and light weight are perfectly suited for the action photographer. It fits so well into one's hands that it becomes an extension of his reflexes,

3. Mamiya's Moving Coil Electronic Shutter

Mamiya has developed a revolutionary Moving Coil Electronically Controlled Shutter for the Mamiya M645. Electrical consumption of this new shutter is approximately 1/10 that of previous electronic shutters. Furthermore, consumption remains constant regardless of the shutter speed being used. In addition to accuracy, long battery life is assured by this new shutter.

4. Large, Bright Viewfinder

It becomes easy to catch the peak of action when looking through the large, bright viewfinder. Because of the Mamiya M645's automatic diaphragm and quick-return mirror, the viewfinder never grows dim. It is always bright, ready for the next photograph.

5. Interchangeable Finders

■ Lightweight, dual-function Waist-Level Finder S

A compact and lightweight finder which opens and closes with a single touch, the Waist-Level Finder S is ideal for copying, close-ups, low and high angle pictures, and working in dim light. Additionally, it is instantly convertible to an eye-level sports finder which accurately shows the fields for the 80,110,150 and 210mm lenses, allowing one to easily follow the quickest action.

■ Prism Finder

The Prism Finder is well-suited for action photography. Whether the vertical or horizontal format is utilized, focusing and following action is as easy as on a 35mm SLR.

■ PD Prism Finder

The PD Prism Finder employs silicon cells for full-aperture, center-weighted readings. It is your assurance that every negative will be properly exposed.

- **CdS Prism Finder with built-in meter**

Accurate through-the-lens exposure measurement is possible with the CdS Prism Finder which couples to the aperture of the lens and indicates the proper shutter speed to set on the camera.

6. Flatness of the Film Plane

Developed through Mamiya's long experience as a manufacturer of 120/220 roll-film cameras, the Roll-Film Inserts for the Mamiya M645 keep the film perfectly flat for edge-to-edge sharpness. Inserts are available for 120 or 220 roll-film.

7. Multi-Coated Lenses

Mamiya-Sekor lenses have achieved world-renown as professional lenses of exceptional contrast, high resolution, clear definition, and excellent color balance. All the lenses for the Mamiya M645, from wide-angle to telephoto, have been multi-coated to maintain their high standard of performance even under adverse lighting,

8. Unlimited Scope

A full range of accessories are available for the Mamiya M645 to assist the photographer in capturing virtually any type of image. Accessories include hand grips, interchangeable focusing screens, and auto extension rings

complete with meter coupling.

- **Multiple-Exposure Provision**

Merely lowering the multiple-exposure lever allows the photographer to take as many multiple-exposures as he wishes. During multiple-exposures, the exposure counter does not move.

- **Mirror Lock-Up**

The Mamiya M645 is designed to have minimal mirror shock; nevertheless, when it is necessary to completely eliminate vibrations, all you have to do is lock the mirror in the up position. To do so, simply lower the mirror lock-up lever. Mirror lock-up provision makes close-up and telephoto photography possible even at slow shutter speeds.

- **Two Shutter Release Buttons**

The Mamiya M645 is equipped with two ideally located shutter release buttons, so that regardless of how you hold the camera, there is always a release button at your finger tips.

- **Built-in Delayed Shutter Release**

- **Depth-of-Field Preview Lever**

A single touch on the Depth-of-Field Preview Lever, which is ideally located on the camera body, stops the lens down to the preselected aperture for direct viewing of the depth-of-field.

Specifications

● Camera Body

Camera Type:

6 x 4.5 cm electronic focal-plane shutter SLR.

Film Type:

120 roll-film for 15 exposures,
220 roll-film for 30 exposures

Actual Negative Size:

56 x 41.5mm (2-13/64" x1-41/64")

Standard Lenses:

Mamiya-Sekor C (multi-coated)
80mm f/1.9, automatic diaphragm,
with meter coupler, 67mm filter size
Mamiya-Sekor C (multi-coated)
80mm f/2.8, automatic diaphragm,
with meter coupler, 58mm filter size

Lens Mount:

Mamiya M645 bayonet mount

Shutter:

B, 8-1/1000 sec.
Moving Coil Electronic Focal-Plane Shutter,
FP and X (1/60 sec.) synchronization,
Shutter release lock and shutter speed dial lock
provision

Battery Type:

One 6V silver-oxide battery 4SR44
(Eveready 544, UCAR 544, Mallory PX28)
or 6V alkaline battery 4LR44

Focusing Method:

Each Mamiya-Sekor lens is equipped with its own
helicoid focusing mount

Focusing Screen:

The standard focusing screen, which is interchangeable, has three focusing aids, a central split-image rangefinder spot (wedge set at a 45° angle) surrounded by a micro-prism collar and outer ground glass ring. A Fresnel lens assures corner-to-corner brightness, and 94% of the picture-taking area is visible.

Mirror:

Instant return, with mirror lock-up provision

Film Transport:

A single revolution of the interchangeable film advance crank transports the film. The camera is equipped with double exposure prevention, but multiple exposure can be easily made.

Exposure Counter:

Progressive type, automatic reset, automatic changeover with insertion of 120/220 roll-film inserts

Battery Check:

Depressing B.C. button illuminates green L.E.D. if battery condition is satisfactory.

Multiple-Exposure:

Lowering multiple-exposure lever makes multiple-exposures possible; exposure counter does not move during multiple-exposures.

Delayed Shutter Release:

Variable time delay of 5-10 seconds.

Depth-of-Field Preview Lever:

Spring-loaded, self-returning.

Interchangeable Finders

Prism Finder:

The image in the Prism Finder is right-side up, laterally correct, and moves in the correct direction; magnification of 0.74X with the standard lens at infinity, built-on hot-shoe; comes with eyecup.

PD Prism Finder:

Prism Finder with built-in silicon cell, through-the-lens, full-aperture, center-weighted metering: 7 LED's visible in the viewfinder for correct or compensated exposure, with 100 ASA and f/1.9 lens, meter coupling range of EV -1.15 – +19 (f/1.9, 8 sec.- f/22, 1/1000 sec.); with f/2.8 lens, EV 0- 19 (f/2.8, 8 sec. – f/22, 1/1000 sec.); camera body battery serves as power source; other features same as Prism Finder.

CdS Prism Finder:

Prism Finder with CdS through-the-lens, full-aperture, center-weighted metering; zero method with indicator needle; couples to aperture and shutter speed manually set, power source, one 1.5V silver oxide battery SR44 or alkaline battery LR44, with 100 ASA and f/1.9 lens, meter coupling range of EV 2.85 - 17 (f/1.9, 1/2 sec. - f/11, 1/1000 sec.): with f/2.8 lens: EV 4 - 18 (f/2.8, 1/2 sec. - f/16, 1/1000 sec.); other features same as Prism Finder.

Waist-Level Finder S:

Opens and closes with a single touch; magnification of 1.3X (w/standard lens at infinity); diopter correction lenses interchangeable with standard magnifier; built-in sports finder shows field for standard lens and accepts a mask for 110,150, and 210mm lenses, all fields showing approximately 80% of the picture-taking area.

Dimensions and Weight:

(width, height, depth, w/80mm f/1.9 lens)

(w/Waist-Level Finder S)	(w/1.9 lens)	(w/2.8 lens)
3-29/32" x 3-15/16" x 6-9/16" (99.3 x 100 x 166.5mm)	55.4 oz (1570 g)	49.6 oz (1405 g)
(w/Prism Finder)		
3-29/32" x 4-27/32" x 6-9/16" (99.3 x 122.7 x 166.5mm)	62.3 oz (1765 g)	56.4 oz (1600 g)
(w/PD Prism Finder S)		
3-29/32" x 4-29/32" x 6-9/16" (99.3 x 124.7 x 166.5mm)	66.5 oz (1885 g)	60.7 oz (1720 g)
(w/CdS Prism Finder)		
3-29/32" x 4-29/32" x 6-9/16" (99.3 x 124.7 x 166.5mm)	67.2 oz (1905 g)	61.4 oz (1740 g)
Depth w/80mm f/2.8 lens; 6-1/16" (154mm)		

Names_and_Functions of Parts (1)

Focusing screen

Five different types are available.

Focusing screen lug

Mounting guide pin for finder

Fits into the finder opening.

Alignment dot

Alignment reference point for mounting lens.

Depth of Field Preview

A slight upward push on the lever stops lens down to preselected aperture, spring-loaded for self-return.

Shutter release button (front)

When pushing in on this button, the upper shutter release button is coupled to move in unison. Equipped with cable release socket.

Shutter release lock ring

Turn lock ring and align with red dot to simultaneously lock both shutter release buttons. To unlock, align with white dot.

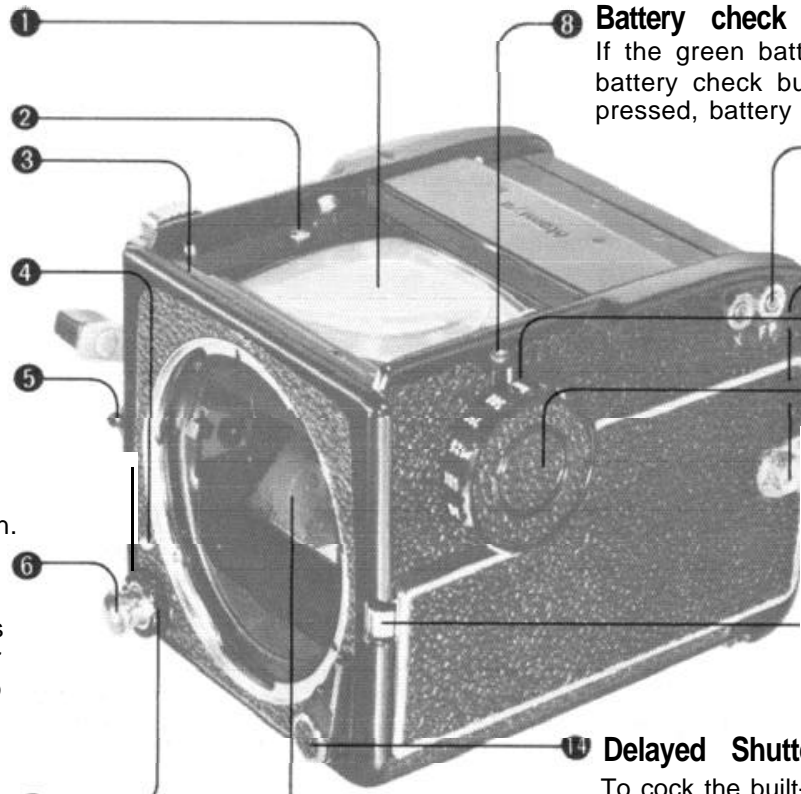

Battery check lamp

If the green battery check lamp glows when the battery check button on the opposite side is depressed, battery condition is good.

Flash sync terminals

With safety cover, only the cover of the sync terminal being used is removed.

Neck strap lug

Shutter speed alignment mark

Shutter speed dial

Push in on safety lock built into the center of the shutter speed dial while rotating dial to desired speed. Do not set dial to the  position unless using the PD or AE Prism Finder.

Lens release button

Push in and simultaneously turn the lens counterclockwise to remove.

Delayed Shutter Release Lever

To cock the built-in delayed shutter release, turn the lever clockwise. Upon removing your finger from the lever it will return to its former position, leaving the activating lever exposed. Push the activating lever in the direction of the engraved arrow to start the delayed shutter release.

Mirror

Never touch the surface of the mirror.

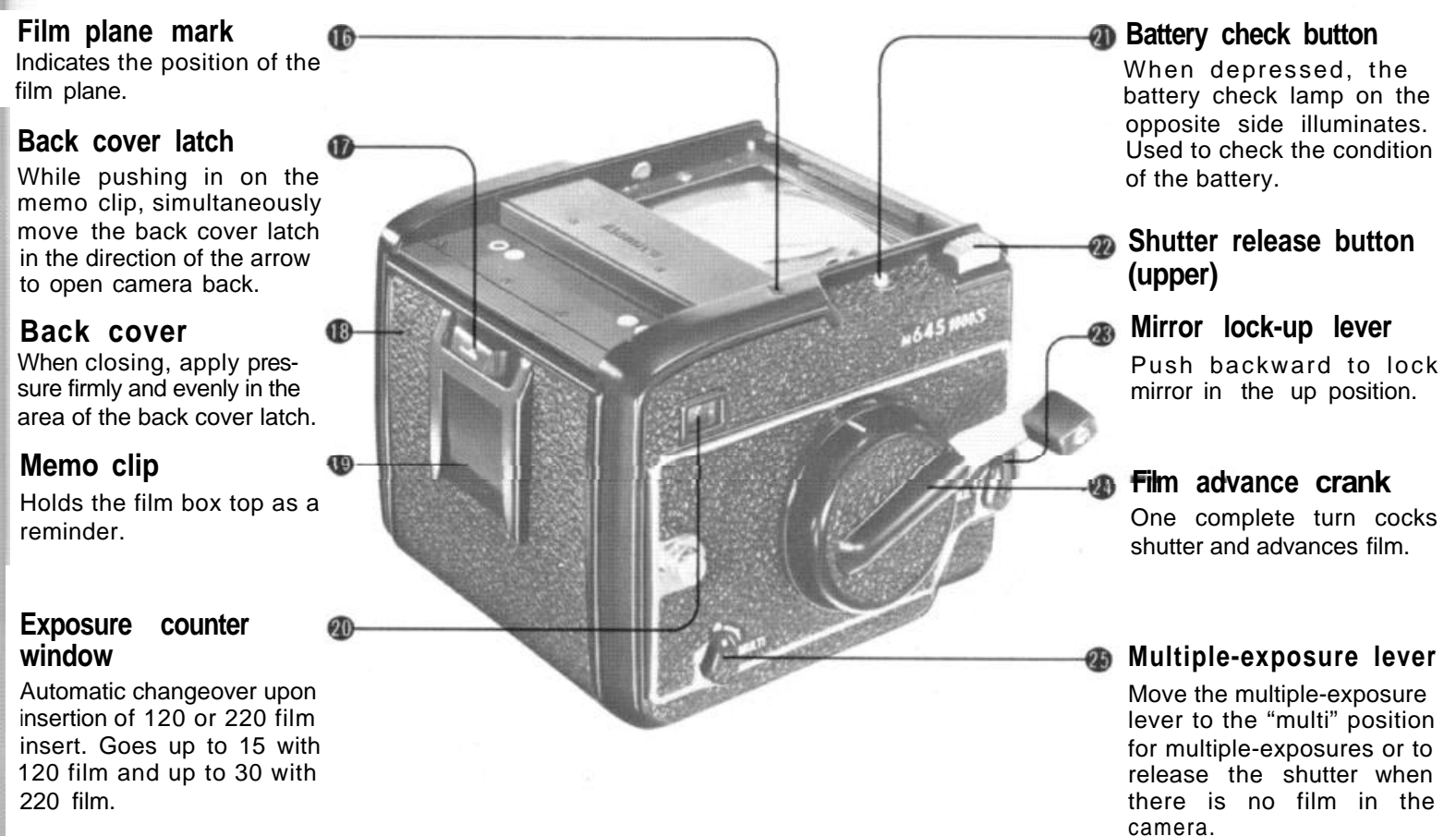

Names and Functions of Parts (2)

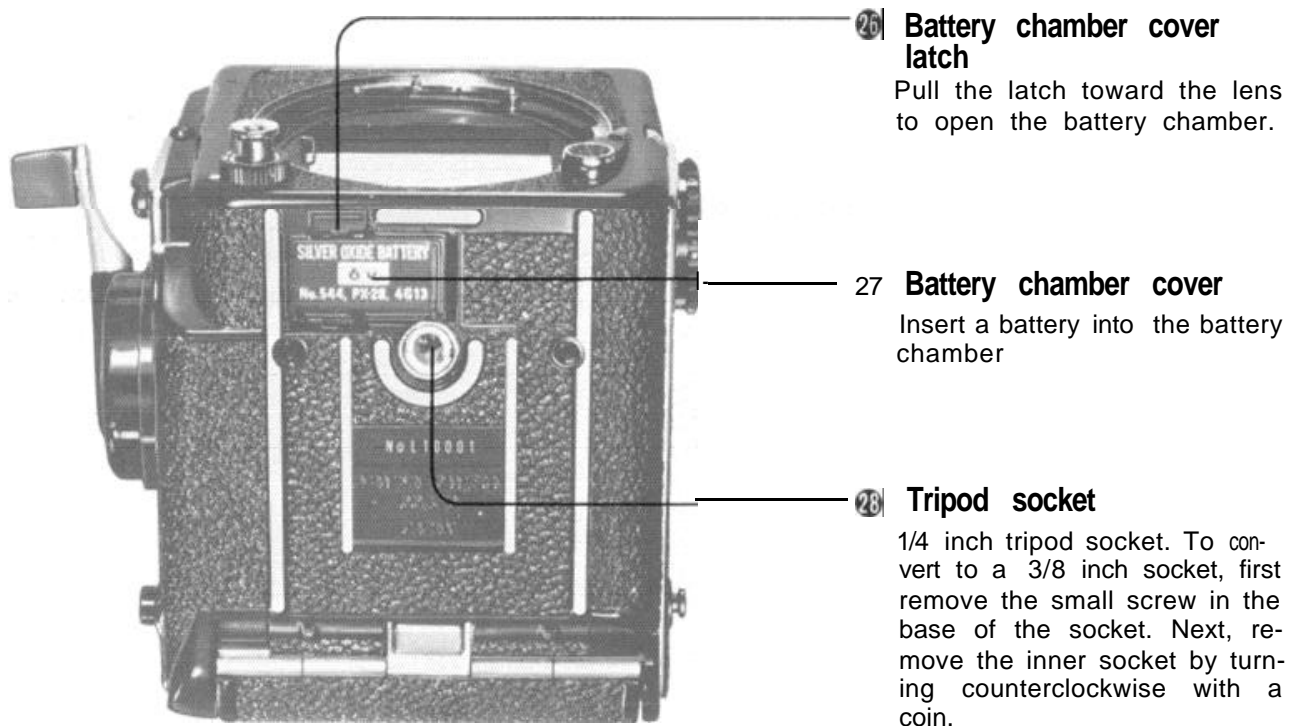

A.M. Lever

Automatic diaphragm operation when "A" appears in the window. Diaphragm stopped down to preselected aperture when "M" appears in window.

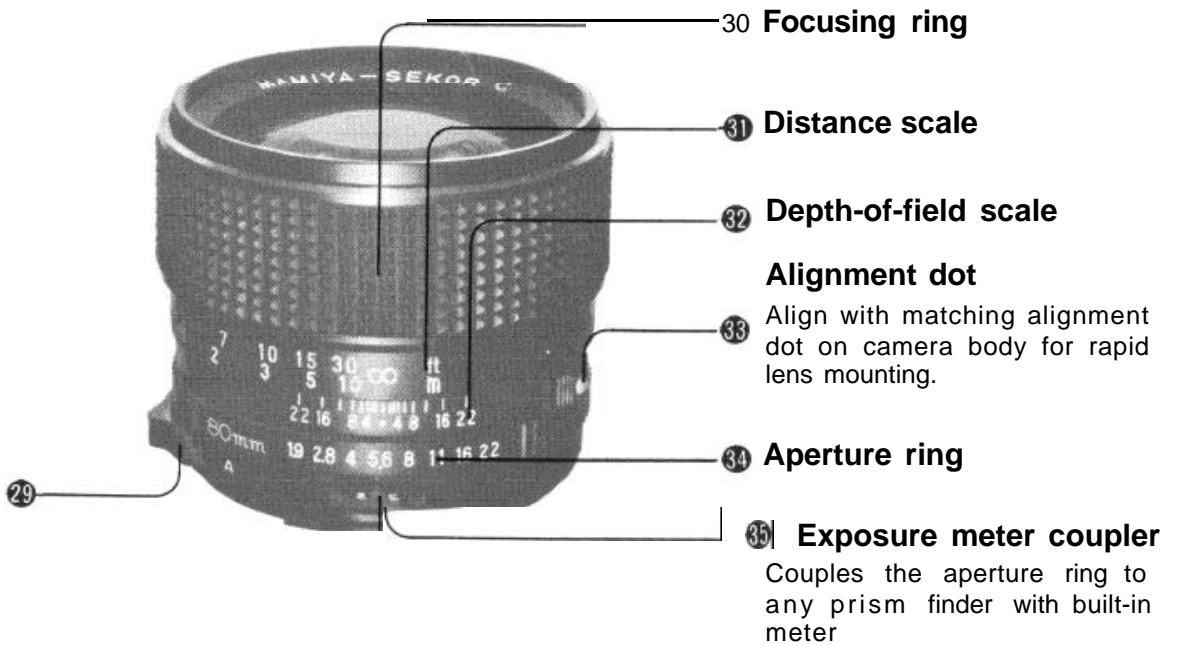

Names and Functions of Parts (3)

Roll-Film Insert

(120 and 220 roll-film inserts are available)

Start Mark

After aligning the start mark on the film's leader paper with this mark, the roll-film insert is ready for insertion into the camera.

Release latch

After squeezing in on both sides of release latch, the roll-film insert can be pulled out of camera.

Spool clip

Pull out and lower spool clip to insert or remove film spools.

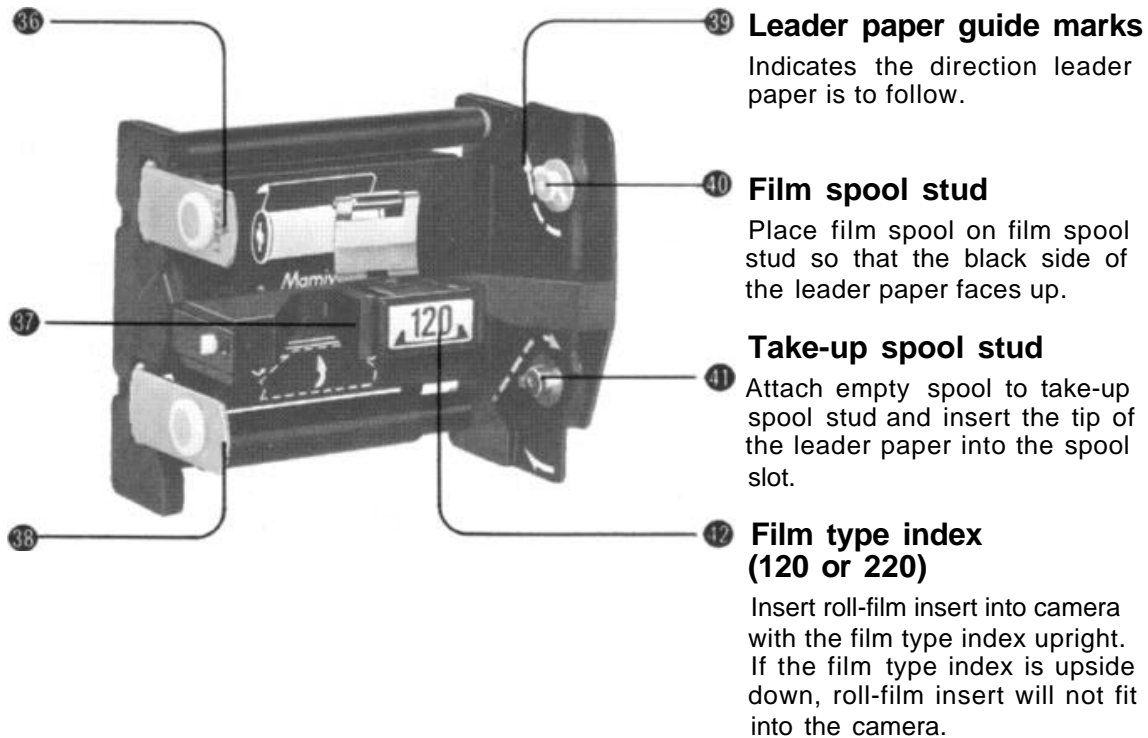

Prism Finder

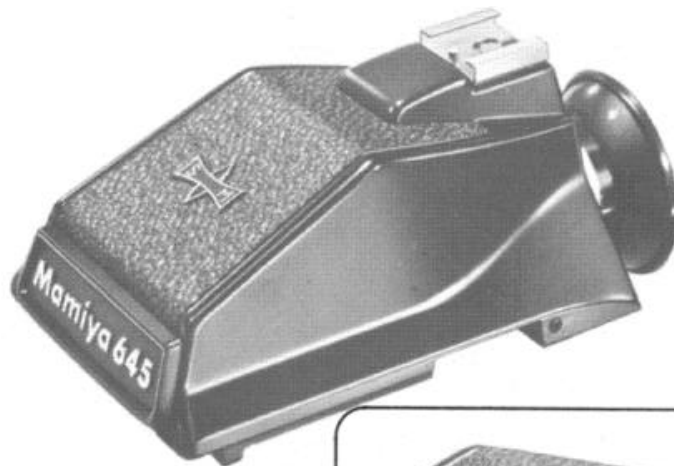

Hot-shoe (with safety cover)
Automatically fires cordless flash units when the shutter release button is depressed.

Eyepiece
Accessories such as eyecup, magnifier, and angle finder can be attached.

Finder release button
Turn clockwise until it stops, push in, and the finder can be lifted off the camera body.

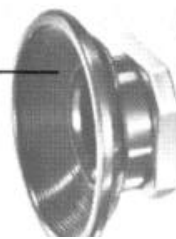

Eyecup
Attach by sliding into the grooves of the eyepiece.

Diopter correction lens retainer ring
Remove by unscrewing in a counterclockwise direction. After inserting correction lens, replace retainer ring.

Names and Functions of Parts (4)

PD Prism Finder S

(Detailed Instructions on pp. 35-38)

Aperture ring coupling pin

Couples to the exposure meter coupler on the aperture ring.

Hot-shoe

(with safety cover)

Automatically fires cordless flash units when the shutter release button is depressed.

Eyepiece

Accepts accessories such as eyecup, magnifier, and angle finder.

Eyecup

Attach by sliding into the grooves of the eyepiece.

Diopter correction lens retainer ring

Remove by unscrewing in a counterclockwise direction. After inserting correction lens, replace retainer ring.

Meter switch

Pushing in on this switch when the finder is attached to the camera will turn on the meter and a LED in the finder will light up. Even if you release pressure from the meter switch, the meter will remain on for approximately 15 seconds and then automatically turn off to conserve electricity.

Shutter speed dial

ASA window

ASA dial

Pull out and then turn.

Finder release button

Turn clockwise until it stops, push in, and the finder can be lifted off the camera body.

CdS Prism Finder

(Detailed instructions on pp.39-43)

Aperture ring coupling pin

Couples to the exposure meter coupler on the aperture ring.

Hot-shoe (with safety cover)

Automatically fires cordless flash units when the shutter release button is depressed.

Eyepiece

Accepts accessories such as eyecup, magnifier, and angle finder.

Eyecup

Attach by sliding into the grooves of the eyepiece.

Diopter correction lens retainer ring

Remove by unscrewing in a counterclockwise direction. After inserting correction lens, replace retainer ring,

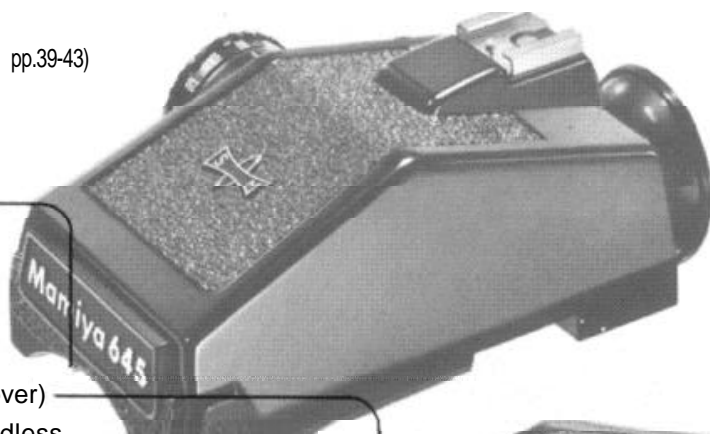

Shutter Speed Dial

Be sure to manually set the shutter speed dial of the camera body to the speed indicated by this dial.

Power switch

Set to OFF when the meter is not being used.

ASA dial

Pull out and then turn

ASA window

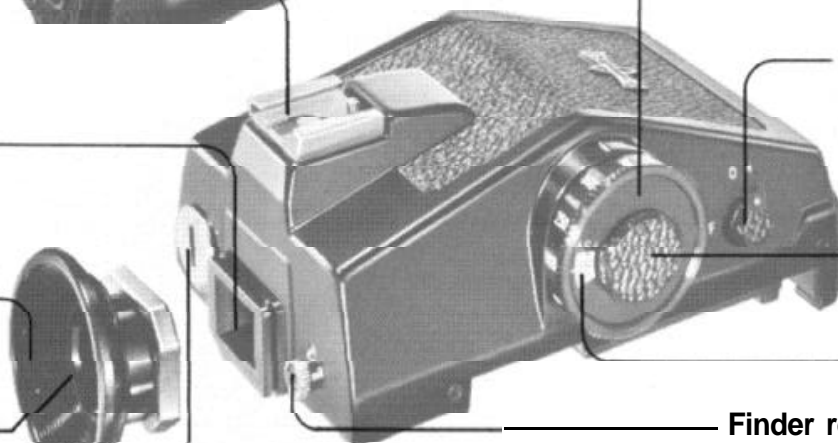

Finder release button

Turn clockwise until it stops, push in, and the finder can be lifted off the camera body.

Battery chamber cover

Remove the cover with a coin and insert a 15V battery into the chamber



Names and Functions of Parts (5)

Waist-Level Finder S (For detailed instructions, see pp. 44-46)

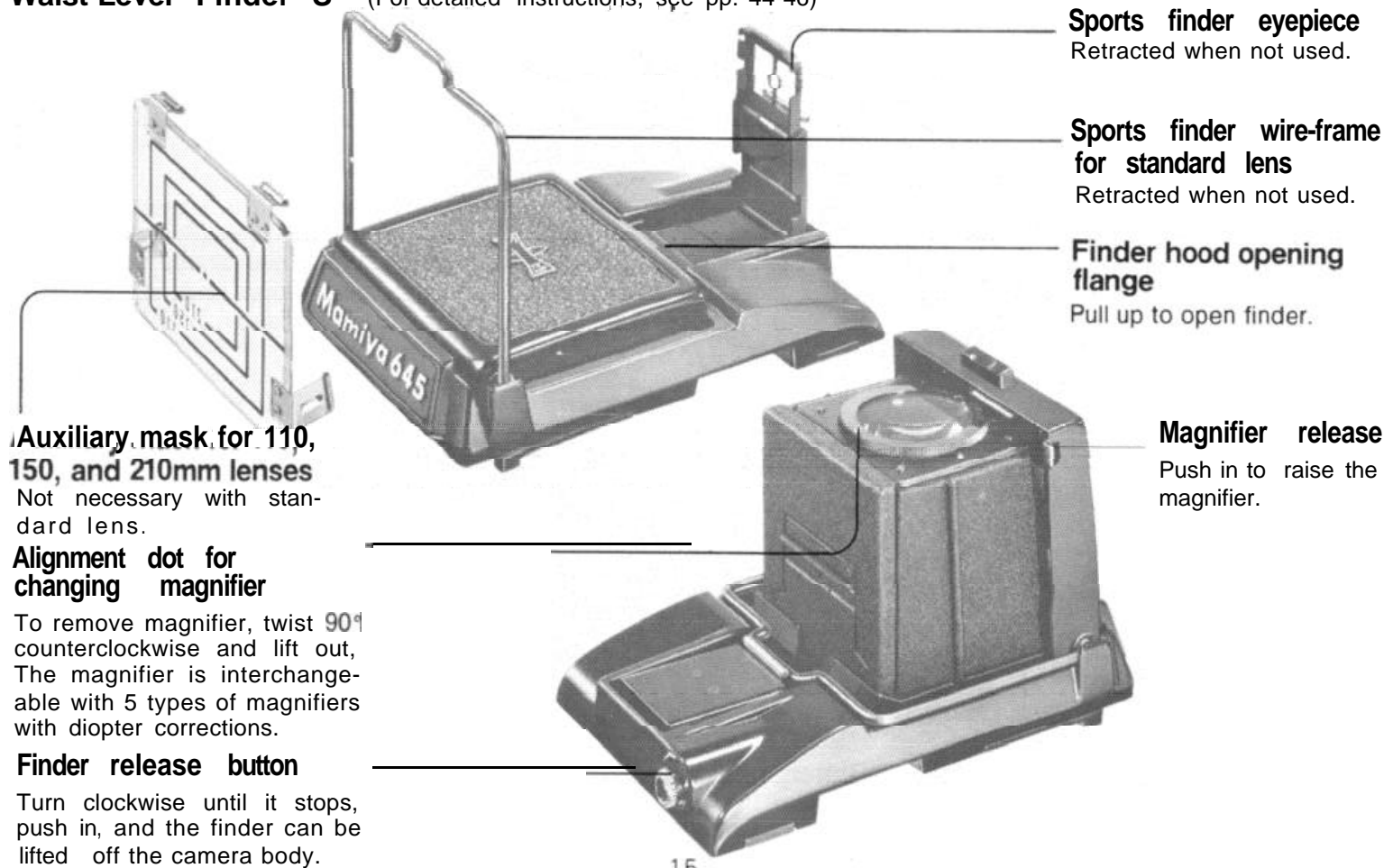

Testing to See if the Camera Functions Properly

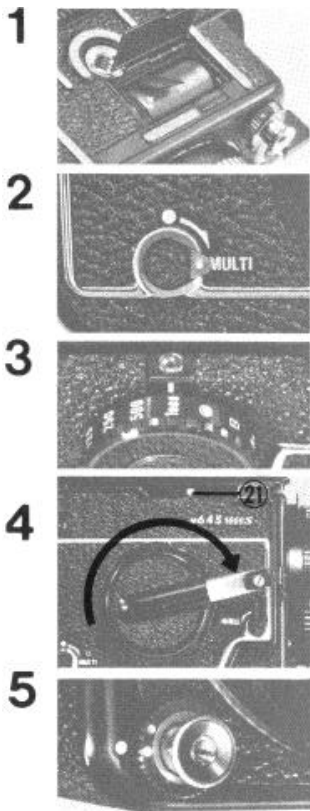

To release the shutter when there is no film in the camera, proceed as follows. [For detailed instructions on particular points, refer to the page number shown in parentheses.]

1. Insert a battery into the camera (p.21).
2. Set the multiple-exposure lever to "MULTI" (p.50).
(If you have just purchased the camera and the vinyl tube is still on the take-up spool, there is no need to move the multiple-exposure lever.)
3. Set the shutter speed dial to any shutter speed other than the  red mark (p.27).
4. Turn the film advance crank until it stops.
5. Align the shutter release lock ring with the white dot and release the shutter (p.30).

When ready to load the camera with film, return the multiple-exposure lever to its normal position. If this is not done, the film will not advance.

If the shutter is released without a battery in the camera, the mirror will lock in the up position. To return the mirror to its normal position, depress the battery check button (21) as far as it will go.

If the shutter is released with the shutter speed dial set to the red  position, the mirror will lock in the up position. To lower the mirror, turn the shutter speed dial in either direction (B or 1/1000 sec.).

At times it may be necessary to rotate the film advance crank two full turns to cock the shutter when an empty take-up spool (without its original vinyl tube) is in the camera.

Interchanging Lenses

● Removing the body cap

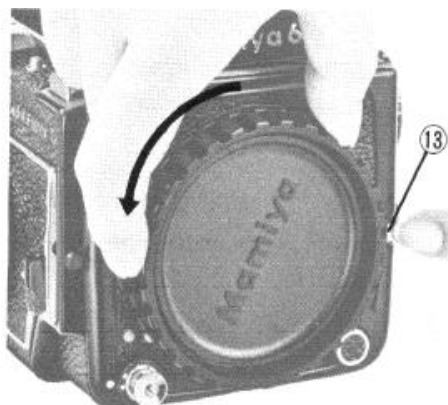

While depressing the lens release button (13) turn body cap counterclockwise until the red dots are aligned and lift out.

The upper body cover can be removed by merely sliding backwards and lifting,

● Attaching Lenses

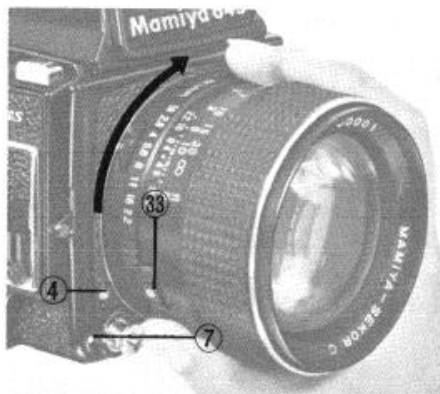

While aligning the two alignment dots (33 & 4), insert lens into camera body. Then twist lens clockwise until it clicks and locks into place.

● Removing Lenses

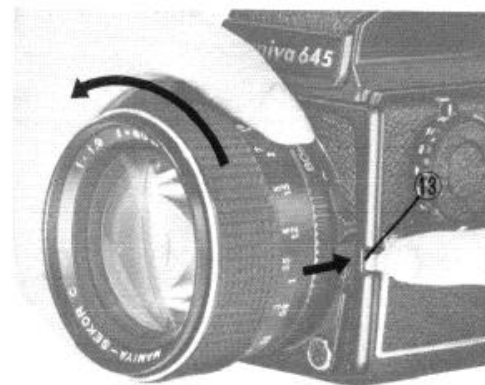

While depressing the lens release button (13) grasp the part of the lens barrel that has the depth-of-field scale (32) and alignment dot (33) and twist the lens counterclockwise until it stops. Then lift out.

Interchanging Finders

*After removing a lens, be sure to place caps on both the lens and camera body.

*Never touch the surface of the mirror.

*After removing a lens, it is recommended to lock the shutter release button by setting the shutter release lock ring (7) in order to avoid accidentally releasing a cocked shutter when placing the camera body face down on a table.

All finders are interchanged in the same manner.

Prior to attaching the finder to the camera, confirm that the white dot on the finder release button is pointing upward.

If the white dot on the button is aligned with the white dot on the finder, by depressing the button and removing your finger from it, the white dot on the button will automatically point upward. In this condition, the button cannot be depressed; consequently, the finder will not be accidentally detached from the camera.



• Attaching Finders

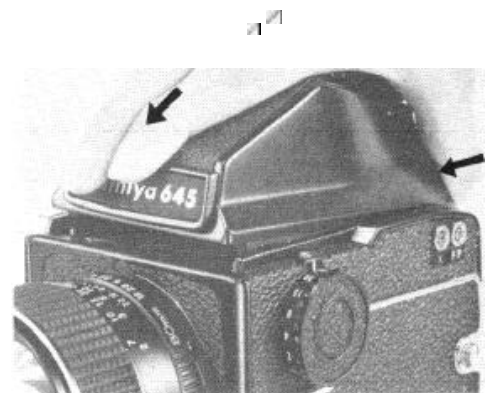

Place the rear part of the finder on the camera body while holding the front part of the finder slightly upward. Slide the rear part forward until it stops and gently lower the front part of the finder on to the camera body. It will then lock into place.

● Removing Finders

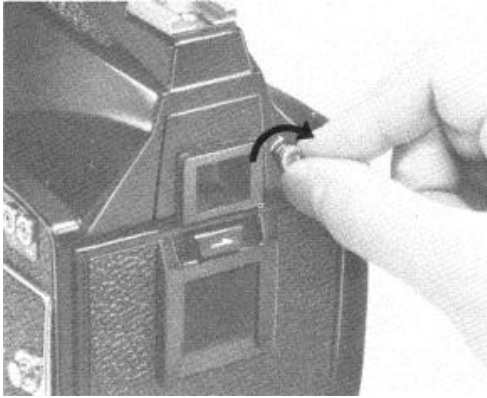

1. Turn the finder release button clockwise until it stops (about 60°). Then you will be able to push in on the release button.

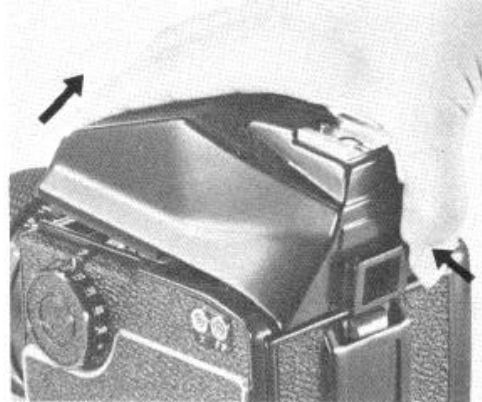

2. While pushing in on the release button with your thumb, lift the finder off the camera body.

Precaution:

Do not leave both white dots aligned by turning the button while the finder is attached to the camera. The finder may become detached when the button is occasionally depressed, possibly causing damage.

If you depress the button to point the white dot upward while the finder is attached to the camera, be sure to depress the finder against the camera body, otherwise the finder will not be locked into place.

Focusing Screens

● Interchanging Focusing Screens

The focusing screens are readily interchangeable. Five different focusing screens are available to meet various photographic needs.

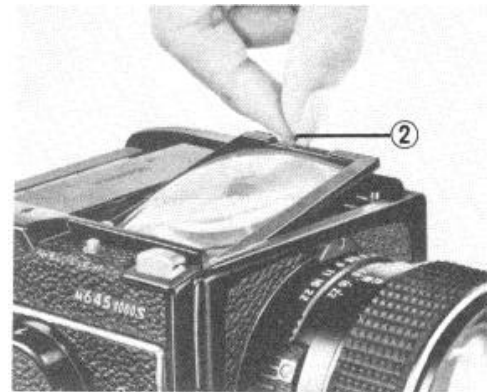

Remove the finder, grasp the focusing screen lug (2), pull up, and lift out. To replace screen, gently insert and lightly push it in on both sides until it stops.

*Since the rear surface of the screen is made of plastic, be careful not to scratch it when interchanging screens.

Inserting a Battery



The Mamiya M645 uses one 6V silver oxide battery 4SR44 (Eveready No 544, UCAR 544, Mallory PX28 or equivalent or alkaline battery 4LR44

1. Pull the battery chamber cover latch (26) slightly toward the lens and the chamber cover will open

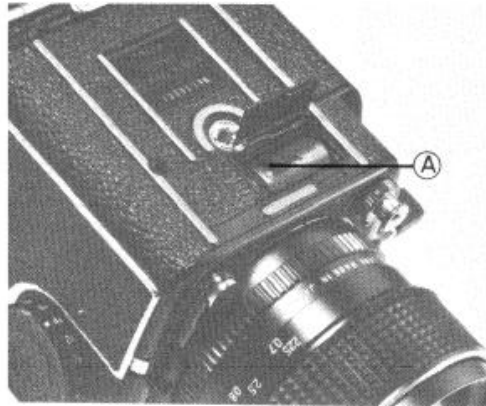

2. Next, insert the battery, exercising caution that the \pm poles match those shown on the diagram of the chamber. Battery removal will be simplified if the battery removal ribbon (A) passes under and over the battery.

CAUTION:

- 1.** Carefully wipe the contacts of the battery before inserting it into the chamber. Failure to do so could result in poor electrical contact and consequent erratic functioning of the camera
- 2.** When the camera is not used for a long period of time, remove the battery and store it in a cool, dry place
- 3.** When replacing a battery, properly dispose of the used battery immediately as it is potentially dangerous. The batteries are explosive and should therefore never be thrown into a fire.
- 4.** A battery that is not used for a long period, even if it is properly stored in a dry, cool place, may lose some of its charge. Consequently, check its condition after replacing it in the camera with the battery check button.

Battery Check

This camera is designed for use with either silver oxide or alkaline batteries. Although both types offer adequate performance, silver oxide batteries last much longer.

IMPORTANT. When using the PD Prism Finder, make it a point to use silver oxide batteries when available (in this instance, battery life is shortened if alkaline batteries are used)

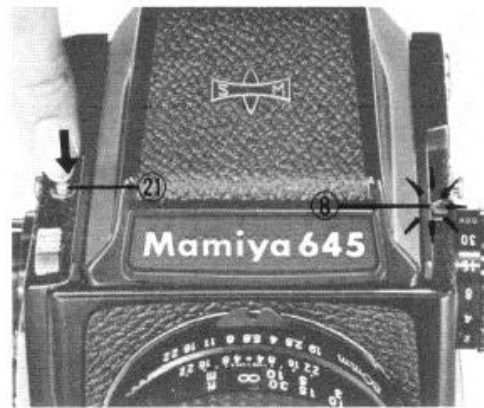

When the battery check button (21, located above the film advance knob) is depressed, the battery check lamp (8, located above the shutter speed dial) illuminates. If the battery check lamp fails to go on, it is time to replace the battery.

* When the battery is completely exhausted, the opened shutter will not close. At this time, **if the battery check button is pushed all the way down as far as it will go, the shutter will then close.**

Film Loading

● Loading the Film

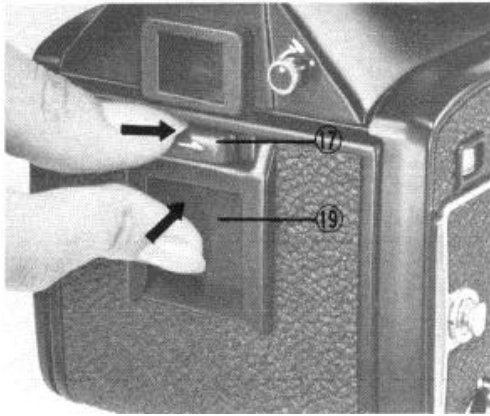

1. While gently pushing in on the memo clip (19), move the back cover latch (17) in the direction of the arrow and the camera back cover will open.

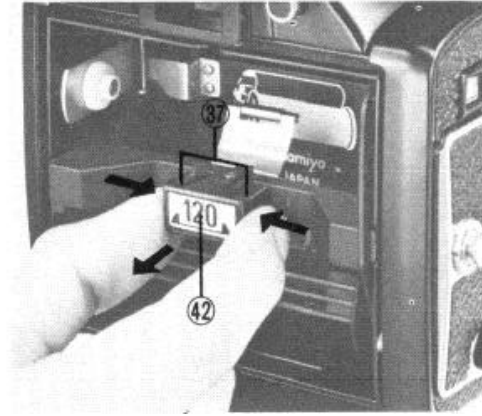

2. While squeezing in on both sides of the release latch (37) pull the roll-film insert out of the camera body. Place the film insert on a table making sure that the film type index (42) is not upside down. Then pull out and lower the spool clips found on the left-hand side

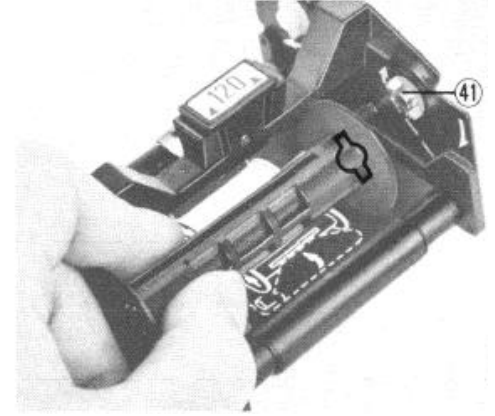

3. Align the right-hand side of an empty spool with the lower spool stud (41). Then return the spool clip (38) to its former position, making sure that the left-hand side of the spool is properly held by the spool clip.



4. In the same manner insert a roll of film in the upper compartment.
5. Make sure that the black side of the leader paper faces up.

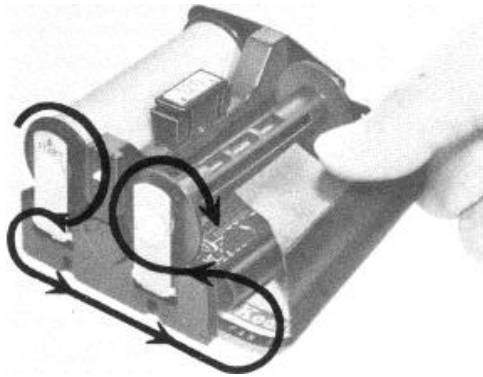

6. Gently pull out some of the leader paper, pulling it over and around the pressure plate. Then insert the tip of the leader paper into the slot of the take-up spool.



7. Gently rotate the take-up spool in the direction of the arrow until the start mark of the film is aligned with the start mark on the spool clip (36).

***! The above step is to be completed before the roll-film insert is placed into the camera.**

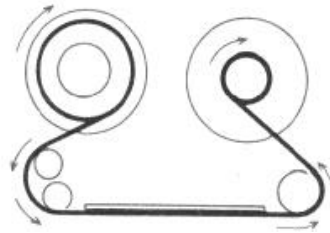

* Never load film in direct sunlight. Load it in the shade or in your own shadow.

* Roll-film inserts for both 120 and 220 film are loaded in the same manner. The exposure counter advances to 15 when the 120 film insert is used, and to 30 when the 220 film insert is used.

Make absolutely sure to match the film insert with the film type being used. If the wrong insert is used, the correct film plane will not be maintained and optimum sharpness will not be achieved. Moreover, if 120 film is used in the 220 film insert, there is the danger of the leader paper getting caught in the shutter causing damage to the camera.

* Before placing the film insert into the camera, make sure the leader paper on the take-up spool is flat and lies evenly between the two edges of the take-up spool. The take-up spool should be wound sufficiently tight to make it impossible for the leader paper to ride over the edge of the take-up spool.

* **Always align the start marks of the film and spool clip before placing the film insert into the camera. (If the start marks are aligned within the camera with the aid of the film advance crank, the first frame will not be correctly positioned.)**

● Using Roll-Film Designed for Six Exposures

If you wish to use roll-film designed for six 6x6cm exposures, follow the procedure outlined below.

1. Load the film in a 120 film insert and use in the normal way. The film will take 7 exposures.

2. After 7 exposures have been taken, set the shutter speed dial to 1/500 sec., wind the film advance knob and release the shutter 4 more times (the exposure counter will indicate "11").

3. Wind the film advance knob once again so that the exposure counter indicates "12", open the back cover, and remove the film insert. (Do not release the shutter when the exposure counter indicates "12".)

4. Completely wind the remaining leader paper around the film take-up spool.

* If the film in the camera is completely wound onto the take-up spool, there is the danger of the tip of the leader paper getting caught in the shutter curtain and damaging the camera.

● Insertion of the Film Insert

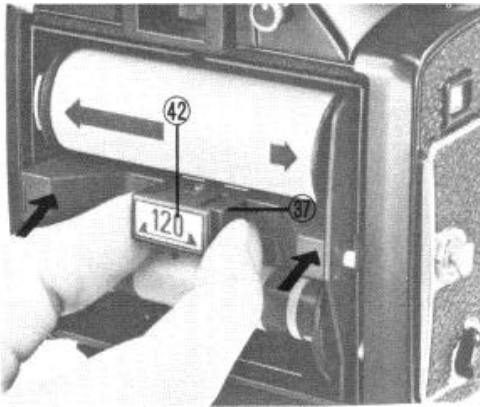

1. Grasp both sides of the release latch (37) of the film insert, making sure that the film type index (42) is not upside down, and place the film insert straight into the camera body. After the film insert has completely entered the camera body, let go of the release latch.

2. Press in on the outer edges of the release latch (indicated by the arrows in the photograph above) and the roll-film insert will lock into place. (If the roll-film insert does not go all the way in on the right-hand side, turn the film advance crank slightly while pushing in on the right side of the film insert.)

3. After insertion has been completed, securely close the camera back cover.

* If the film advance crank moves slightly from the time the film insert is placed into the camera to the time the back cover is closed, there will be no ill effects. However, if the film advance crank moves too much, the first frame will be fogged.

● Memo Clip



The memo clip found on the camera back cover can be used to hold the film box top.

* The memo clip also doubles as a safety lock to prevent the camera back from accidentally opening. If excessively thick paper is placed in the memo clip, it will no longer simultaneously serve as a safety lock.

Film Advancing

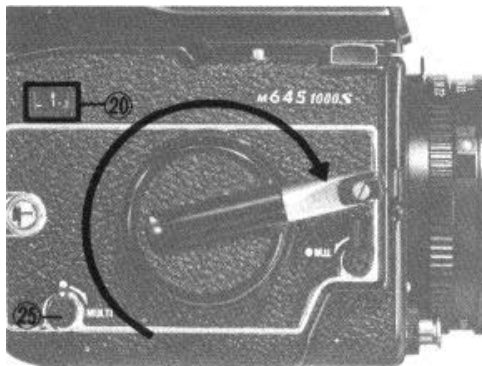

1. After the film has been placed into the camera make sure that the multiple-exposure lever (25) is aligned with the white dot and not with the word "MULTI".
2. Wind the film advance crank until it stops and the number 1 will appear in the exposure counter window (20). The shutter is now cocked and the camera is ready for the first exposure.

Shutter Speed Dial

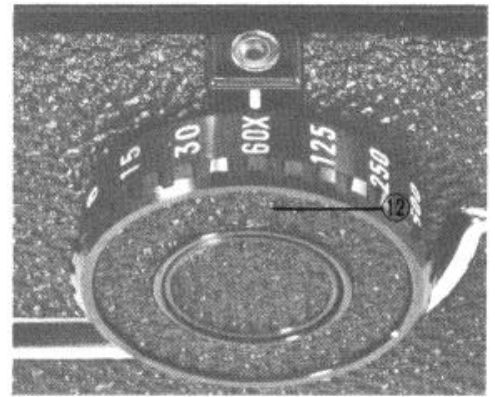

1. Align the shutter speed of your choice with the white alignment index by rotating the shutter speed dial (12) in either direction while pushing in the safety lock button located in the center of the dial
2. **Color Coding**
 - (a) Green figures represent full seconds, all other figures represent the denominator of a fraction. (Thus, 30 equals 1/30 sec.)
 - (b) Orange represents caution. The shutter speeds appearing in orange are not suitable for hand-held shooting. Use a tripod.

Aperture Ring/Stop-down Operation

(c)The red B represents BULB. The shutter will remain open as long as the shutter release button is depressed when the shutter speed dial is set to B.
(d)The red 60X represents the highest permissible shutter speed for electronic flash synchronization.

(e) The red  mark is the position the shutter speed dial is set to when the PD Prism Finder is used.

* If the shutter is released with the shutter speed dial set to the  position and the PD Prism Finder is not attached to the camera, the shutter will lock in the open position. **If the camera is left in this condition, the battery will lose its power within several hours, so rectify the situation at once.** (Moving the shutter speed dial to B or 1/1000 sec. will close the shutter.)

*While gently pushing in on the safety lock button, the shutter speed dial can be set to any click-stop and then locked into place by releasing the lock button; however, the shutter speed dial can not be used at intermediate speed positions.



Set the desired f/stop on the aperture ring (34) by aligning the f/number with the red reference dot (A). (The aperture ring has a click stop for each f/stop. In-between clicks can also be used)

● Depth-of-Field Preview Lever

Keep the AM lever of the lens (29) at the Auto position (the letter A is visible), and whenever desiring to view the depth-of-field, merely push all the way upward on the depth-of-field preview lever (5) to stop the lens down to the preselected aperture. Releasing the preview lever will return the lens to its maximum aperture.

● AM Lever

Moving the AM (Auto/Manual) lever(29) of the lens so that M is visible will stop the lens down to the preselected aperture.

*When desiring to use the depth-of-field preview lever with the 70mm f/2.8 lens (w/built-in between-the-lens shutter), first set the shutter speed ring of the lens to F (Focal plane shutter) index mark.

Focusing



1. While looking through the viewfinder, adjust the focusing ring (30) until the most important part of the subject appears sharp.

2. Extremely accurate focusing is simplified by the split-image rangefinder spot located in the center of the focusing screen. Its wedge is set at a 45° angle, making it possible to use either horizontal or vertical lines of the subject for precise focusing. The split-image rangefinder spot is surrounded by a microprism collar which fractures the image whenever it goes slightly out-of-focus; consequently, it is an invaluable aid for pinpoint focusing accuracy.

3. The outer ground glass ring (which encircles the microprism collar) can also be used for focusing.

Since the Mamiya M645 is an SLR, the photographer always sees in the viewfinder exactly what will appear on the film, regardless of the lens or accessory being used.

Moreover, simply moving the depth-of-field preview lever upward will allow one to preview the depth-of-field and appearance of out-of-focus images.

* As an accessory, Mamiya offers diopter correction lenses which can be attached to the prism finders, and diopter lenses for the waist-level finder. Near and farsighted persons will find these accessories useful for obtaining accurate focus.

Shutter Release and Film Transport Mechanism

● Shutter Release Lock Ring

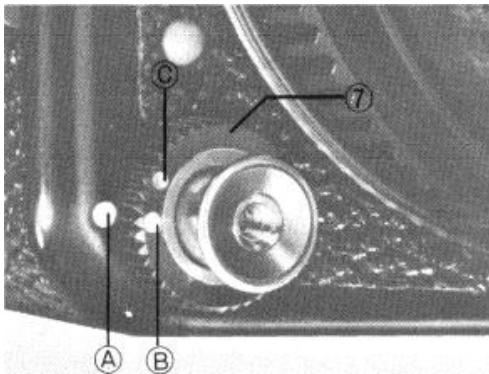

The shutter release button is equipped with a lock ring to prevent accidental release of the shutter.

1. When you wish to release the shutter, turn the shutter release lock ring so that the white dot (B) is aligned with the dot (A) on the camera body.
2. Aligning the red dot (C) of the shutter release lock ring with the dot on the camera body will simultaneously lock both shutter release buttons.

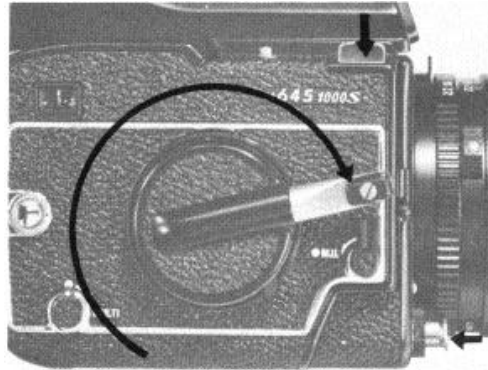

1. When releasing the shutter, you may use either the front or upper shutter release button.
2. After releasing the shutter, the film advance crank is automatically unlocked, making it possible to transport the film to the next frame.

Please notice the following points regarding the film transport mechanism:

- * A built-in safety lock prevents the shutter from being released if the film advance crank is not fully wound or if the exposure counter is between S and 1

- * After the fixed number of exposures has been taken (15 or 30), the shutter release button automatically locks.

- * If the film is advanced while depressing the shutter release button, the shutter will be released at the instant the film is fully advanced. Do not attempt to take pictures in this manner as a degree of camera shake is inevitable.

- * If the PD Prism Finder is not attached to the camera body and the shutter is released with the shutter speed dial set to the @ position, the mirror will lock in the raised position and the shutter will remain open. (Moving the shutter speed dial to B or 1/1000 sec. will lower the mirror and close the shutter.)

- * Use of the multiple-exposure lever is explained on page 50.

- * The front shutter release button is threaded to accept cable releases.

- * Do not strongly depress the upper shutter release button while simultaneously advancing the film. If this is done, the film advance automatic stop mechanism will be disengaged, and the film will advance even during the operation of the shutter. Moreover, the

Unloading Film

mirror may lock in the up position, which results in rapid depletion of the battery. Should the mirror lock in the raised position for the above reason, first continue to rotate the film advance crank until it stops (after the fixed number of exposures (15 or 30) have been taken, the film advance crank should be rotated more than one full turn), then lower and raise the mirror lock-up lever, and the mirror will return to its normal position, simultaneously terminating needless electrical consumption

(The only time it is necessary to strongly depress the upper shutter release button is in the event that the mirror locks in the raised position upon releasing the shutter when working at extremely low temperatures. At such a time, if the film is advanced after first strongly depressing the release button, then lower and raise the mirror lock-up lever, the mirror will lower and the camera will be ready for the next exposure.)

1. After the fixed number of exposures have been taken (15 for 120, 30 for 220) the shutter release button will lock. At that time, wind the film advance crank until the leader paper is completely wound onto the take-up spool. (When winding is complete, resistance will no longer be felt on the film advance crank.)
2. Open the back cover, remove the roll-film insert and the exposure counter will reset to S (Start). **The exposure counter will not reset to S if the insert is not removed.**
3. Remove the film from the film insert, exercising care that the film does not loosen, and seal it.

The Neck Strap

Methods of holding the camera securely

● Attaching to Camera

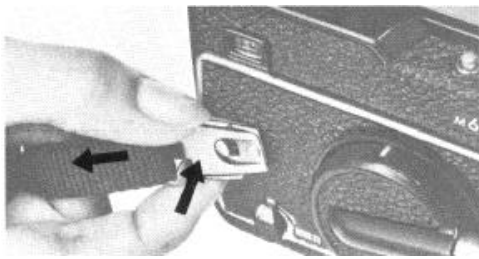

Place the neck strap fastener over the neck strap lug on the camera body and gently pull it away from the camera while pressing it toward the body until it clicks and locks in place.

● Removing from Camera

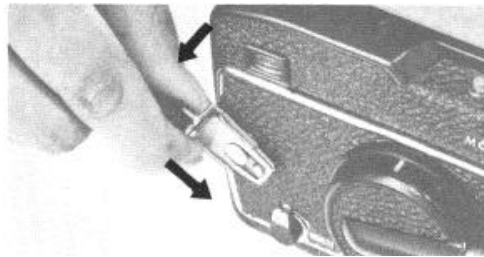

While pushing in on the rear blade of the neck strap fastener with your thumb, slide it forward and remove.

● Eye Level Operation

No matter how carefully one focuses the camera, if there is camera movement during the instant the shutter is released, sharp pictures are unlikely. To eliminate camera movement, care must be taken regarding the method of holding the camera and releasing the shutter.

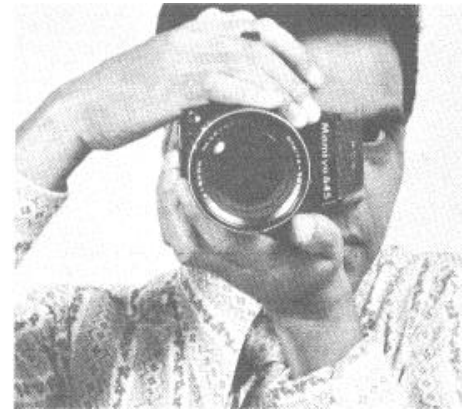

● Waist-Level Operation

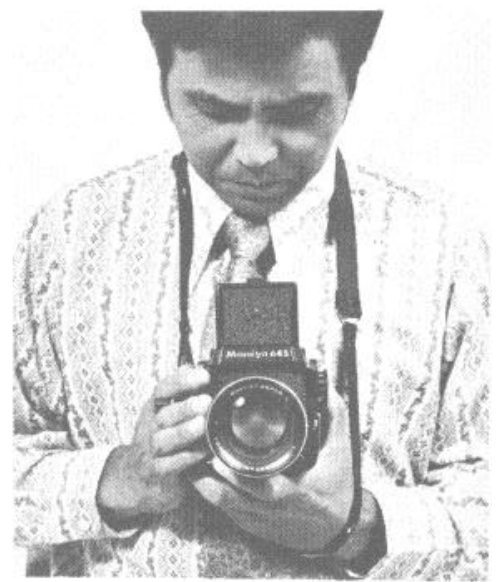
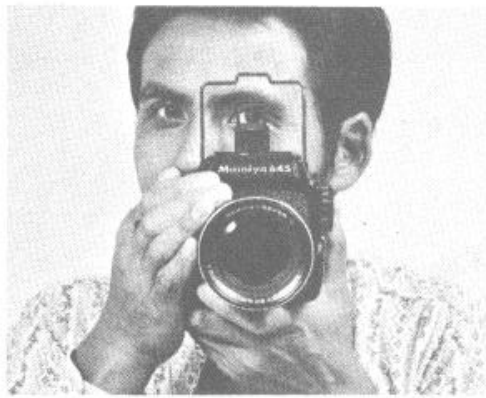
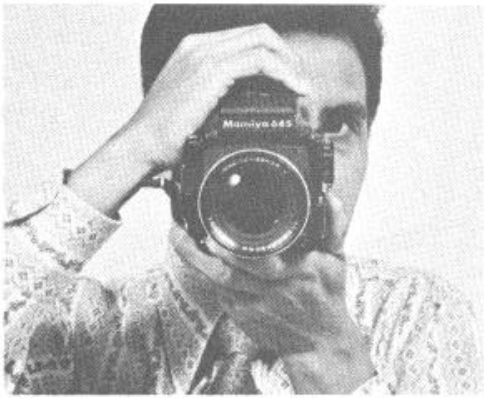

● Hand Grips

When hand-holding the camera with the waist-level finder attached, adjust the length of the neck strap to take up all slack and support the camera against the body. As accessories, Mamiya offers a selection of hand grips which not only help to eliminate camera-shake, but are also convenient for carrying the camera.

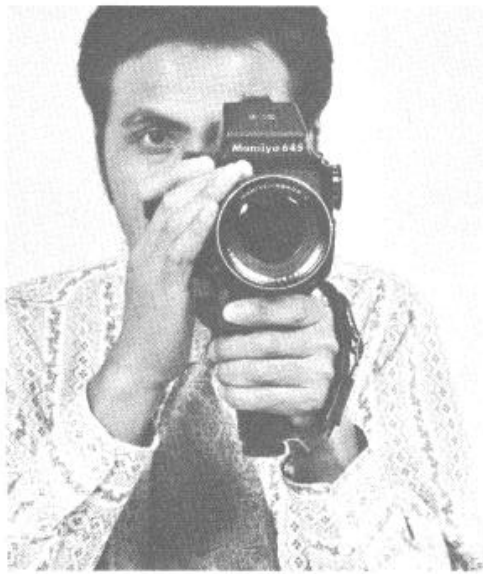

Using the PD Prism Finder S (1)

● Special Features

1. The PD Prism Finder is an eye-level finder with a built-in silicon photo diode exposure meter and electronic shutter control circuit.
2. The PD Prism Finder offers complete coupling of the lens aperture, shutter speed, and film speed (ASA)
3. Seven LED's are built into the viewfinder system. A green LED indicates correct exposure and red LED's indicate over, under, and compensated exposure
4. The built-in meter covers a broad range, is highly accurate even in dim light, and has a rapid response because it utilizes silicon photo diodes.

● Specifications

Viewfinder: 0.74 magnification with standard lens at infinity, built-on hot-shoe, comes with eyecup.

Metering System: Center-weighted, through-the-lens, full-aperture metering. One green and six red LED's built into the viewfinder system for correct exposure determination.

Meter Coupling Range: (with f/1.9 lens and 100 ASA film)
EV -1.15 — +19
(f/1.9, 8 sec. — f/22, 1/1000 sec.)
(with f/2.8 lens and 100 ASA film)
EV 0 — 19
(f/2.8, 8 sec. — f/22, 1/1000 sec.)

Shutter Speed Range: 1/1000 — 8 sec.

ASA Range: 25 — 6400
(aperture coupling in the entire range)

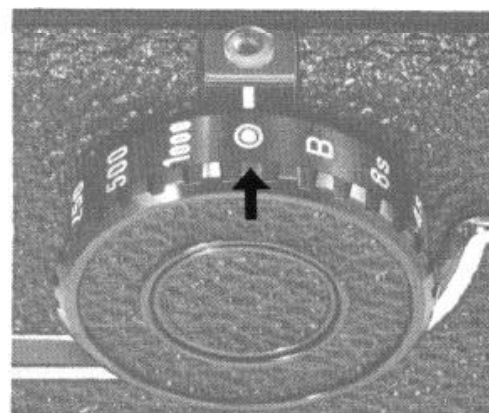

Since the PD Prism Finder utilizes the battery in the camera body, a timer is incorporated into the meter switch of the PD Prism Finder to prevent unnecessary electrical consumption.

1. Set the camera body shutter speed dial to the PD Prism Finder position located between B and 1/1,000 sec.

If the shutter speed dial is set to a position other than \odot the PD Finder and camera body will not be electrically connected. Consequently, the viewfinder LED's will not illuminate.

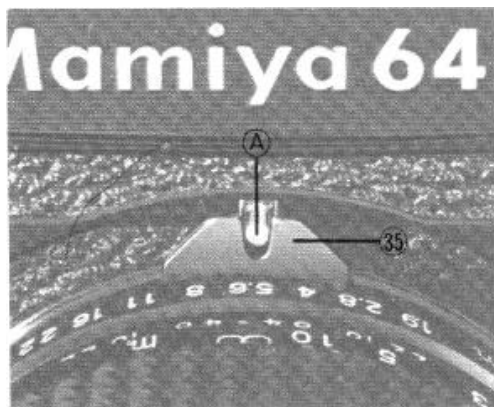

2. Attach the PD Prism Finder to the camera body.

3. Turn the aperture ring of the lens so that the exposure meter coupler (35) of the lens and the aperture ring coupling pin (A) of the PD Finder engage.

★ **Be sure to check for proper coupling.** If the aperture ring coupling pin (A) is not properly seated in the fork of the exposure meter coupler (35), use a pen (or similar device) to push the aperture ring coupling pin into its proper position into the fork.

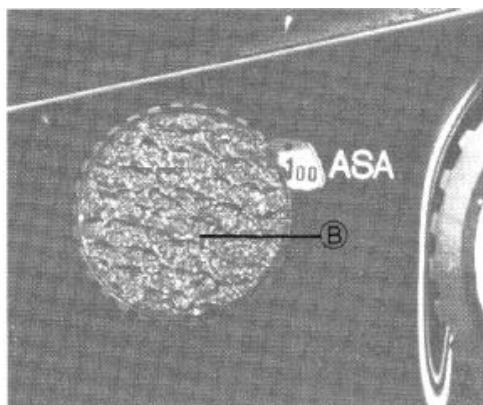

4. Pull out and turn the ASA dial (B) until the appropriate ASA number appears in the window.

***Always set the AM Lever on the lens to "A", otherwise correct metered exposure cannot be obtained. For the same reason, do not touch the Depth-of-field Preview Lever when making an exposure measurement.**

ASA	D I N
6400	(39)
(5000)	• (38)
(4000)	• (37)
3200	(36)
(2500)	• (35)
(2000)	• (34)
1600	(33)
(1250)	• (32)
(1000)	• (31)
800	(30)
(650)	• (29)
(500)	• (28)
400	(27)
(320)	■ (26)
(250)	• (25)
200	(24)
(160)	• (23)
(125)	• (22)
100	(21)
(80)	• (20)
(64)	• (19)
50	(18)
(40)	● (17)
(32)	• (16)
25	(15)

Using the PD Prism Finder S (2)

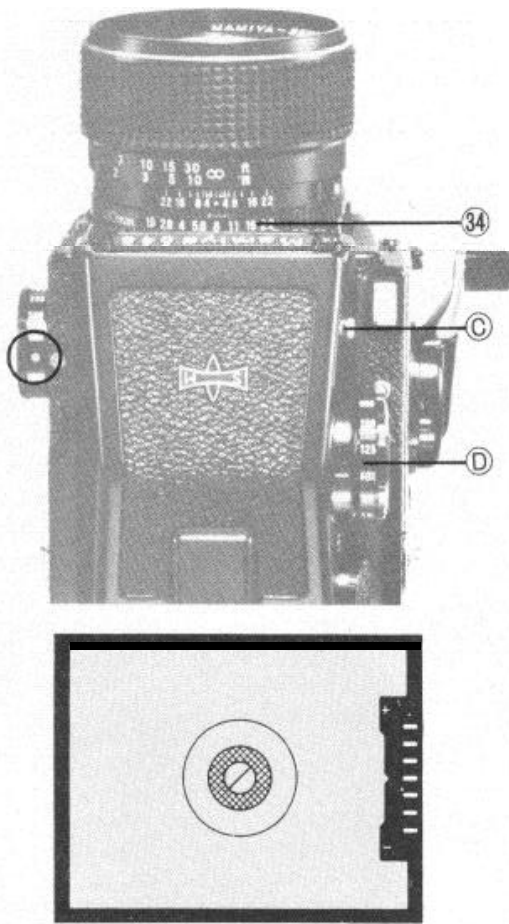

5. Push in and release the meter switch (C) to turn on the meter. With the meter on and while looking through the viewfinder, adjust the aperture ring (34) or shutter speed dial (D) until the central (green) LED in the right-hand side LED panel illuminates, indicating correct exposure.

The meter circuit remains on as long as the meter switch is depressed. After releasing your finger from the switch, it will stay on approximately 15 seconds longer, then the meter will automatically turn off to conserve electrical consumption.

*If two LED's illuminate simultaneously, make fine adjustments with the aperture ring until the central green LED appears the brightest.

*Remember to adjust the shutter speed with the PD finder shutter speed dial and to keep the camera body shutter speed dial set to

*The shutter speed dial has click-stops at full one speed intervals and cannot be used at intermediate positions. Although the aperture ring has click-stops at one stop intervals, intermediate positions may also be used.

*The shutter speed dial of the PD Prism Finder has a strong click-stop at 1/1000 sec. to enable the user to tell by touch alone, without any need to remove his eye from the viewfinder, when he is changing from the adjacent 1/500 sec. or 8 sec. shutter speed to 1/1000 sec.

● Exposure Compensation

The LED Panel incorporated into the PD Prism Finder simplifies exposure compensation, assuring perfect exposures everytime. Each LED represents a full stop increment and plus and minus signs are indicated within the viewfinder to assist in compensating. The uppermost LED represents three or more stops overexposure, and the lowermost LED represents three or more stops underexposure.

● Compensation Hints

1. For strongly back-lit subjects outdoors, set the exposure to + 1 (the red LED directly above the green one).
2. To photograph a person indoors, seated next to a window and strongly back-lit, set exposure to + 2.
3. When photographing interiors, to compensate for the bright interior lights, set exposure to +1 or + 2.
4. When copying white documents, set exposure to +2. If a standard gray card is used to determine exposure, no correction is necessary.

5. When photographing a brightly lit subject against a dark background, such as a night club performer, set exposure to - 1 or - 2.

6. Brightly lit night scenes, such as city streets, are usually rendered most naturally with the correct exposure (green LED).

7. When photographing extremely dark subjects (e.g. close-up of a black cat), set exposure to - 1.

* The exposure compensation or LED panel can also be used to increase the ASA range to 3 - 51200. For example, with the ASA dial set to 25, instead of using the green LED for correct exposure, use the +3 LED when using ASA 3 film.

* Since the upper and lowermost LED's represent 3 **or more** stops difference from the central (green) LED, whenever compensating by 3 stops, first adjust the aperture or shutter speed for 2 stops of compensation and then move the aperture ring or shutter speed dial one more click stop for 3 stops of compensation.

Correct Exposure Measurement

*The TTL metering system of your PD Prism Finder makes it unnecessary to consider such factors as the difference in angle of view of interchangeable lenses, filter factors, or exposure increase for macrophotography. (For accurate exposure measurement when taking close-ups, be sure to carefully read the instructions packed with the auto bellows, reverse ring, etc.)

*In macrophotography, the amount of light reaching the film varies in accordance with the extension of the auto bellows, extension rings, etc. Consequently, for accurate results be sure to first focus on the subject before taking an exposure measurement,

*To prevent extraneous light from entering the eyepiece and influencing the exposure reading, keep your eye close to the eyecup when making an exposure measurement.

Using the CdS Prism Finder (1)

■ Special Features

1. The CdS Prism Finder is an eye-level finder with a built-in CdS exposure meter for accurate exposure measurement.
2. It couples to the aperture when attached to the camera.
3. An exposure meter indicator needle is visible in the viewfinder to indicate correct exposure.

● Specifications

Viewfinder: Unreversed, laterally correct image; 0.74× magnification with standard 80mm lens at infinity; built-in hot-shoe and equipped with an eyecup.

Metering System: Center-weight TTL full-aperture, zero-method via indicator needle.

Meter Coupling Range: (with f/1.9 lens and 100ASA film)

EV 2.85 — 17

(f/1.9, 1/2 sec. — f/11, 1/1000 sec.)

(with f/2.8 lens and 100 ASA film)

EV 4 — 18

(f/2.8, 1/2 sec. — f/16, 1/1000 sec.)

Shutter Speed Range: 1/1000 — 1 sec.

ASA Range: 25 — 6400

(aperture coupling in the entire range)

Power Source: One 1.5V silver oxide battery SR44 (Eveready S-76, Mallory MS-76 or equivalent) or alkaline battery LR44.

● Inserting the Battery

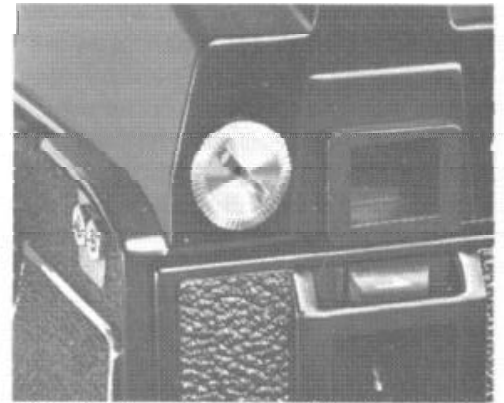

This finder utilizes a 1.5V silver oxide battery SR44 (Eveready S-76, Mallory MS-76 or equivalent) or alkaline battery LR44 as the power source.

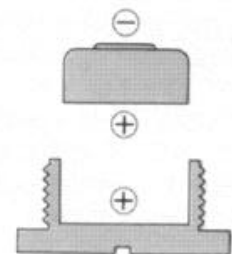

1. Remove the battery chamber cover by rotating it counterclockwise with the aid of a coin.

2. The underside of the battery chamber cover bears a + mark. Be sure to have the + marks of battery and chamber cover face each other as the battery is inserted. Then securely retighten battery chamber cover

*Wipe battery with a soft cloth before inserting into battery chamber, as a soiled battery may fail to make, or maintain, proper contact

*When the finder is not used for a long period of time remove the battery and store it in a cool, dry place.

*Never throw used batteries into a fire, or attempt to charge a battery.

● Method of Use

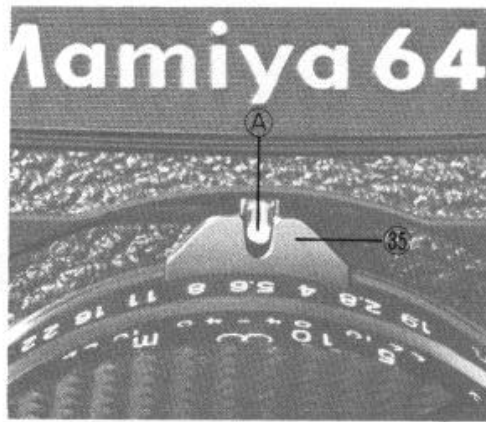

1. Attach the CdS Prism Finder to the camera body.

2. Turn the aperture ring of the lens so that the exposure meter coupler (35) and aperture ring coupling pin (A) of the CdS Prism Finder engage.

***Be sure to check for proper coupling.** If the aperture ring coupling pin (A) is not properly seated in the fork of the exposure meter coupler (35) use a pen (or similar device) to push the aperture ring coupling pin into its proper position into the fork.

***Always set the AM Lever on the lens to "A",** otherwise correct exposure cannot be obtained. For the same reason, do not touch the Depth-of-Field Preview Lever when making an exposure measurement.

Using the CdS Prism Finder (2)

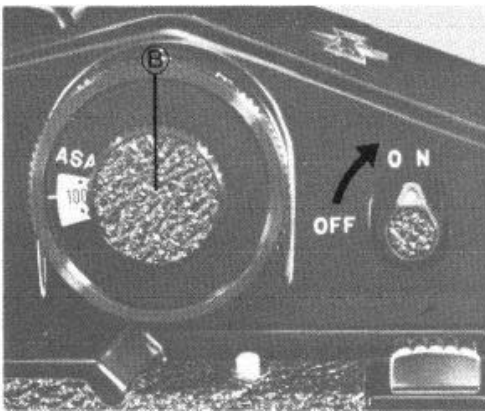

3. Set the meter of the CdS Prism Finder to the correct ASA. To do so, pull out and rotate the ASA dial (B) so that the appropriate ASA number appears in the window, aligned with the index mark.

4. Turn the exposure meter switch to ON.

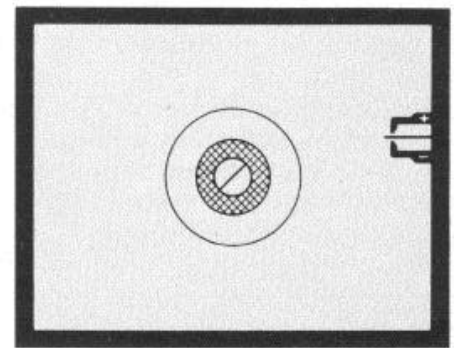
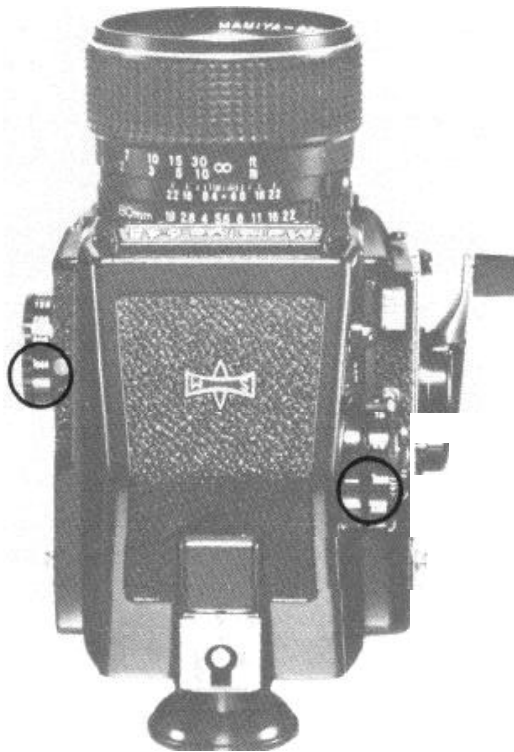

5. Set the shutter speed dial on the camera body to the desired speed, **and then set the shutter speed dial of the CdS Prism Finder to the same speed.**

(Examples of recommended shutter speeds to use with 100 ASA film would be 1/250, or 1/125 sec. outdoors on a sunny day, 1/125 or 1/60 sec. outdoors on a cloudy day, and 1/30 sec. when working indoors.)

6. To set the correct exposure, rotate the aperture ring until the exposure meter indicator needle visible in the viewfinder is centered between the two brackets visible on the right-hand side of the focusing screen.

If the indicator needle cannot be centered even after rotating the aperture ring as far as it will go, the exposure must be adjusted by rotating the CdS Prism Finder shutter speed dial. If the indicator needle is too high, set the shutter speed dial to a shorter ("faster") speed; if too low, set to a longer ("slower") speed. After adjusting the shutter speed dial of the CdS Prism Finder, if the indicator needle is slightly off-center, make final adjustments with the aperture ring.

Whenever changing the setting of the shutter speed dial of the CdS Prism Finder to adjust for exposure, do not forget to set the shutter speed dial of the camera body to the same setting.

7. After the above steps have been completed (centering of the indicator needle), exposure setting should be correct, and the picture may be taken.

● Aperture Priority Method

1. When desiring to set the aperture first set the aperture ring to the desired f/stop, and then adjust for exposure by rotating the shutter speed dial of the finder until the indicator needle is centered between the brackets

2. Check the setting of the finder shutter speed dial, and **set the same setting on the shutter speed dial of the camera.**

*When adjusting for exposure with the CdS Prism Finder shutter speed dial, do not use any intermediate positions, but always set the dial to a click-stop position. If the indicator needle cannot be perfectly centered with the shutter speed dial at a click-stop position, make final adjustments with the aperture ring.

The brackets visible in the viewfinder not only indicate correct exposure, but are also notched to indicate ± 2 f/stops (see diagram) to simplify exposure compensation for unusual lighting. When the exposure meter switch is set to OFF, the indicator needle rests at the bottom position.

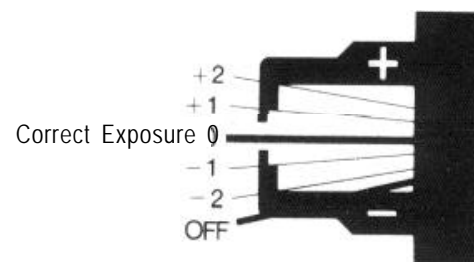

Using the CQS Prism Finder (3)

● Meter Coupling Range

The range of usable shutter speeds varies in accordance with the film speed (ASA). As the shutter speeds shown in the shaded area of the diagram below are beyond the range of the meter, the shutter speed dial is provided with a safety lock to prevent one from entering the non-usable zone. For example, it can be seen from the diagram that 1/8 sec. is in the non-usable zone when using film rated at 800 ASA (or higher); consequently, when the ASA dial of the CdS Finder is set to 800, the shutter speed dial cannot be set to 1/8 sec.

*To conserve battery power, keep the exposure meter switch set to OFF whenever the meter is not in use. Even when forgetting to set the switch to OFF, whenever the CdS Prism Finder is removed from the camera, the exposure meter is automatically switched off because of the small safety switch built into the bottom of the finder.

*To obtain optimum results, follow the same precautions outlined for the PD Prism Finder (see "Correct Exposure Measurement", p.38).

Usable Shutter Speeds (unshaded area)

ASA	Shutter Speeds (sec.)											
	1	$\frac{1}{2}$	$\frac{1}{4}$	$\frac{1}{8}$	$\frac{1}{15}$	$\frac{1}{30}$	$\frac{1}{60}$	$\frac{1}{125}$	$\frac{1}{250}$	$\frac{1}{500}$	$\frac{1}{1000}$	
25												
50												
100												
200												
400												
800												
1600												
3200												
6400												

Using the Waist-level Finder S (1)

● Opening the Finder Hood



Pull up on the finder hood opening flange to open the finder.

● Closing the Finder Hood

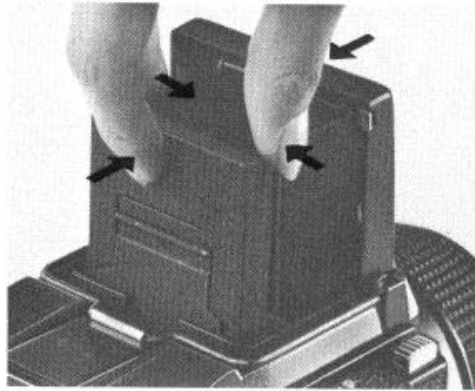

First, push in on the sides; next, push the front cover and back together to fold the finder.

● Raising the Magnifier

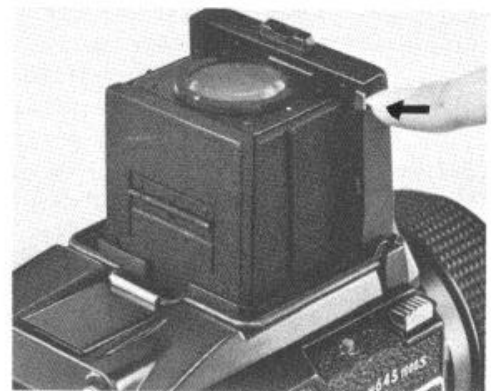

Push in on the magnifier release button to raise the magnifier.

Using the Waist-level Finder S (2)

● Lowering the Magnifier

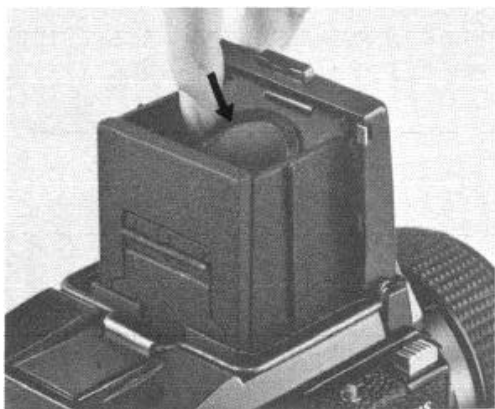

To lower, push down on the edge of the magnifier board until it locks into place.

● Interchanging Magnifiers

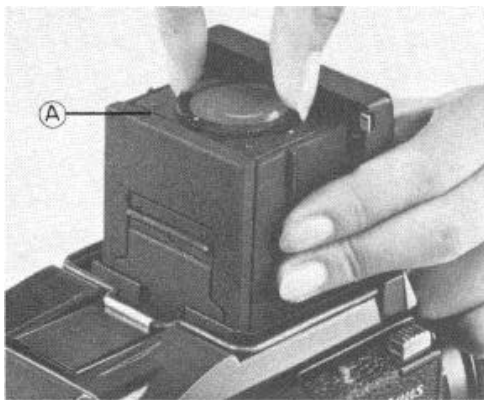

Removing the Magnifier

While holding the finder side panels with the left hand so that the magnifier board (A) is not lowered, grasp the edge of the magnifier with the fingers of the right hand and twist counterclockwise to remove.

Attaching a Magnifier

Align the white dots of the magnifier and magnifier board; drop magnifier into magnifier board, and twist clockwise until magnifier clicks and locks into place.

* In addition to the standard magnifier (-1.5 diopters), magnifiers of + 2, +1, 0, - 2, and - 3 diopters are available for near and farsighted users.

The standard -1.5 diopter magnifier is designed for users, whether eyeglass wearers or not, that have no trouble seeing a subject 2.5 ft. (70cm) away clearly. For those who have difficulty seeing clearly at such a distance, or for those who wish to remove their eyeglasses in order to see the entire focusing screen field, please use a diopter lens which is available as an optional accessory. However, before making a purchase, try the diopter lens at your Mamiya dealer to make sure it matches your eye.

● Using the Sports Finder

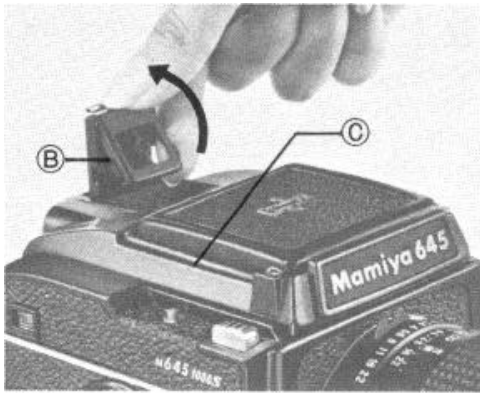

With Waist-Level Finder S in the closed position, first raise the sports finder eyepiece (B) to a vertical position. The eyepiece sight folds into the eyepiece base; when lifted out of the base, the eyepiece sight will stay in a vertical position because of the eyepiece spring. Next, lift the wire-frame (C) of the sports finder.

As the Waist-Level Finder Hood can be opened even with the sports finder mask raised, focusing can be quickly and easily checked. (However, if the finder hood is first opened, the sports finder wire-frame cannot be raised.)

○ Using the Auxiliary Mask

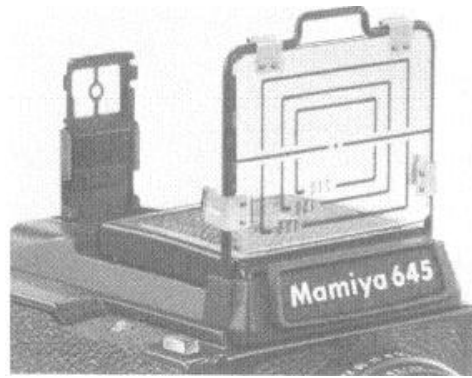

The wire-frame of the sports finder indicates the field for the 80mm lenses. When desiring to use the 110, 150, or 210mm lens, the auxiliary mask must be attached to the wire-frame. When desiring to open the Waist-Level Finder Hood, while the auxiliary mask is attached to the raised frame, first pull the bottom of the auxiliary mask out to the second notch, in order to prevent the auxiliary mask from blocking the finder hood.

Setting the auxiliary mask to the second notch has no adverse effects on the accuracy of the indicated fields; therefore, it is perfectly acceptable to use the sports finder in this condition. Additionally, when the auxiliary mask is set to the second notch, it is also possible to lower it over the closed finder hood, although it is recommended to remove the auxiliary mask before lowering the wire-frame in order to minimize scratches on the surface of the plastic mask.

The Mamiya Moving Coil Electronic Shutter

The electrical consumption of Mamiya's newly developed Moving Coil Electronic Shutter is merely 1/10 that of the electro-magnetic system currently in wide use. Moreover, the consumption remains constant regardless of shutter speed with Mamiya's M. C. Shutter. Therefore, Mamiya has been able to greatly increase battery life. Furthermore, battery performance is maintained at a high level, as indicated in the accompanying diagrams, as the moving coil condenser is normally charged keeping the battery at peak voltage. Thus, the battery is protected from drops in voltage, as when the switch is on.

1. The shutter is closed

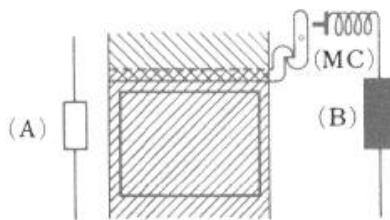

The moving coil energizing condenser (B) is normally charged. (At this time current is not flowing.)

2. First blind moves, opening the shutter when release button is depressed

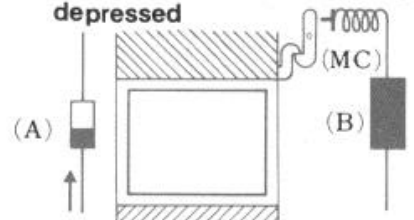

When the first blind moves, the exposure time control condenser (A) begins to charge. (The right-hand latch is holding back the second shutter blind.) The charge-time of condenser (A) is determined by the shutter speed.

3. The instant of exposure

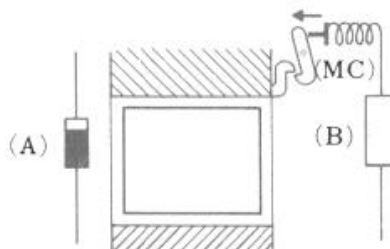

When condenser (A) reaches the determined voltage, condenser (B) discharges, energizing the moving coil which in turn moves the second shutter blind release latch.

4. Second shutter blind moves, closing shutter

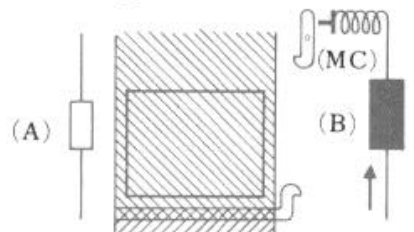

Condenser (B) charges. (The charge-time is extremely short and accomplished by very little electric power.)

Depth-of-Field

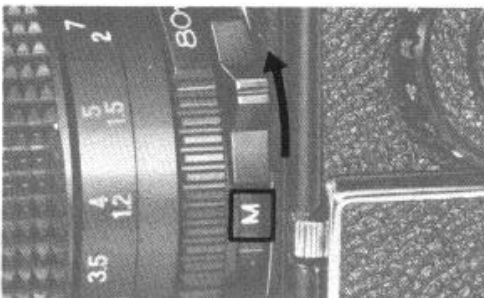
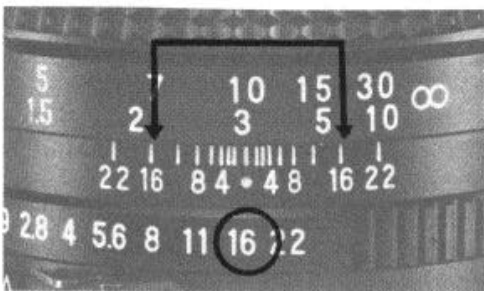
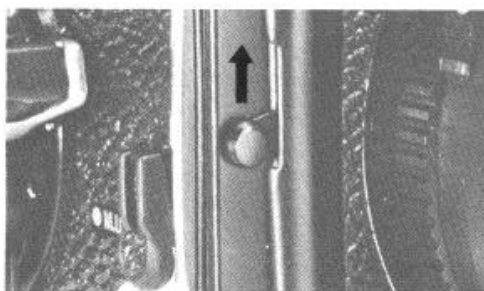

Depth-of-field refers to the total area (foreground and background) which will appear in focus (sharp). The area of sharpness (depth-of-field) depends upon the distance the lens is focused at, the f/stop (or aperture) being used, and the focal length of the lens. The area that will appear sharp can be determined in three ways:

1. The Depth-of-Field can be directly viewed on the focusing screen by gently pushing the Depth-of-Field preview lever upward, as far as it will go. When released, the spring-loaded lever will return to its original position and at the same time, the diaphragm of the lens will return to maximum aperture for bright viewing.

2. The depth-of-field can also be determined by referring to the depth-of-field scale engraved on the lens and which lies directly above the aperture ring. The f/stop numbers are engraved on both the right and left-hand sides of the center reference mark. Simply locate the f/stop (aperture) you are using and read the figures which appear above the f/stop number on the distance scale of the lens. For example, with the 80mm f/2.8 lens focused at 10ft. (3m) and the aperture ring set to f/16, the depth-of-field scale reveals that everything from about 7ft. (2m) to about 20ft. (6m) will appear sharp (see photograph).

3. The lens can also be stopped down to the preselected aperture for direct viewing of the Depth-of-Field by using the AM lever on the lens instead of the camera Depth-of-Field preview lever. To do so, move the lever so that M (Manual) is visible. You can take a picture in this condition while observing the Depth-of-Field.

*When desiring to use the Depth-of-Field preview lever with the 70mm f/2.8 lens (w/built-in between-the-lens shutter), first set the shutter speed ring of the lens to F (Focal plane shutter) index mark.

Using Flash



1. Flash units can be attached to the camera's tripod socket or to the accessory shoe of the hand grip.

2. The Mamiya M645 has two sync terminals which are used in the following way:

(1) When using an electronic flash, plug the synchronization cord into the X terminal and set the shutter speed dial to 1/60 sec. or longer (1/30 - 8 sec.).

(2) When using FP flashbulbs, plug the cord into the FP socket and set the shutter speed dial to 1/60 sec. or shorter (1/125 - 1/1000 sec.).

(3) For MF and M bulbs, use the X terminal and set the shutter speed dial to 1/30 sec. or longer for MF bulbs, and 1/15 sec. or longer for M-type bulbs.

⚠ The Prism and PD Prism Finder are equipped with a hot-shoe and offer cordless flash operation for flash units that have a hot-shoe contact.

* If the flash duration of an electronic flash is longer than 1/1000 sec. (e.g. 1/600 sec.) set the shutter speed dial to 1/30 sec. (not 1/60 sec.) or longer.

⚠ When using flash, carefully read the instructions packed with the flashbulbs or flash unit to avoid making errors.

Precaution when Using Flash

When using the X-sync terminal of the camera body, be sure to insert the plastic safety cover into the hot-shoe, and when using the hot-shoe, be sure to insert the appropriate safety cover into the X-sync terminal. This procedure will prevent the possibility of receiving an electric shock while an electronic flash is attached and accidentally touching the terminal not being used.

Flash Synchronization Chart

Sync Terminal	Shutter Speeds													
	1/1000	1/500	1/250	1/125	1/60	1/30	1/15	1/8	1/4	1/2	1	2	4	8
FP	FP Class													
X						Electronic flash								
						MF Class								
						M, FP Classes								

Multiple-Exposures

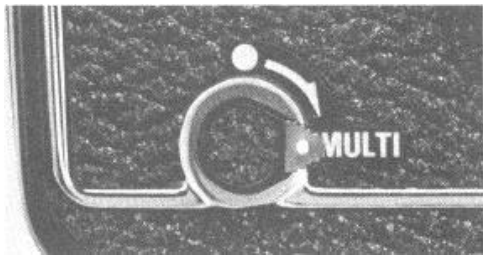

When the white dot of the multiple-exposure lever (25) is aligned with MULTI, the double-exposure prevention mechanism is disengaged, so that the shutter can be cocked with the film advance crank without moving the film, making multiple-exposures possible. (When making multiple-exposures, the exposure counter does not advance.)

When desiring to make a multiple-exposure, set the multiple-exposure lever to MULTI. (It can be set to MULTI either before or after the initial exposure of the multiple-exposure.) After making the initial exposure, recock the shutter with the film advance crank and then make the second (double) exposure, repeating as often as desired.

Remember to return the multiple-exposure lever to its original position upon completion of the multiple-exposure.

* To release the shutter when there is no film in the camera, set the multiple-exposure lever to "MULTI".

Infrared Photography

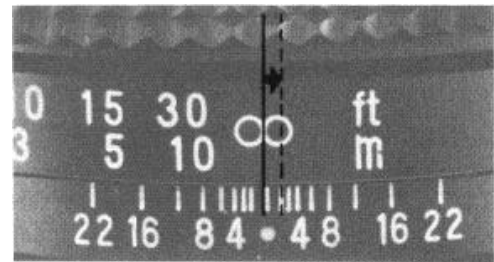

When using infrared film it is necessary to make a focusing adjustment in order to achieve accurate focus. This focusing adjustment is particularly important when:

- a) using non-wide-angle lenses
- b) taking close-ups
- c) shooting at wide apertures

Focusing Adjustment Procedure

1. The red dot or line on the right side of the center reference line (also red) is the infrared mark.
2. After focusing in the usual manner, check the distance on the distance scale that is aligned with the center reference mark of the lens, and then make the focusing adjustment by turning the focusing ring slightly in the direction indicated by the arrow in the accompanying photograph so that the distance just observed is aligned with the infrared mark.

* For information regarding the proper filter and exposure, refer to the data sheet packed with the film.

Mirror Lock-up

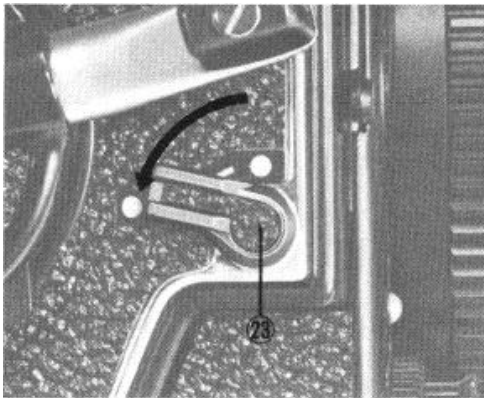

When the camera is mounted on a tripod for copy work or telephotography at long (slow) shutter speeds, the small amount of vibrations due to "mirror-bounce", which normally are of no consequence, may cause blurring of the image due to the high magnification encountered in extreme close-ups and telephotography. Mirror shock can be eliminated by locking the mirror in the up position before making the exposure.

1. To lock the mirror up, merely move the mirror lock-up lever (23) backwards, until it is horizontal (the lever may be lowered either before or after cocking the shutter).

2. With the shutter cocked, release the shutter with a cable release. After releasing the shutter, you may wind the film advance crank with the mirror still in the up position if you wish.

* Return the mirror to its normal position immediately after completing all of your mirror lock-up photography.

*When using the 70mm f/2.8 lens (w/between-the-lens shutter), be sure to refer to the instructions packed with the lens.

Using the Delayed S Shutter Release

Attach the camera to a tripod or place it on a firm support. (If the camera support protrudes beyond the front of the camera body, cock the delayed shutter release before placing it on the support).

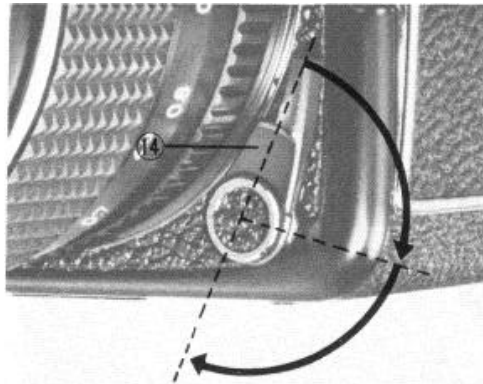

1. Advance the film and cock the shutter with the film advance crank
2. Cock the delayed shutter release by rotating the lever (14) clockwise. When fully rotated (approx. 180°) there will be a 10 sec. delay, and when rotated approximately 90°, there will be a 5 sec delay before the shutter is released. (Rotating the lever less than 90° will fail to cock the delayed shutter release.) When the spring-loaded delayed shutter release lever (14) is released, it will return to its original position, exposing the activating lever (A)

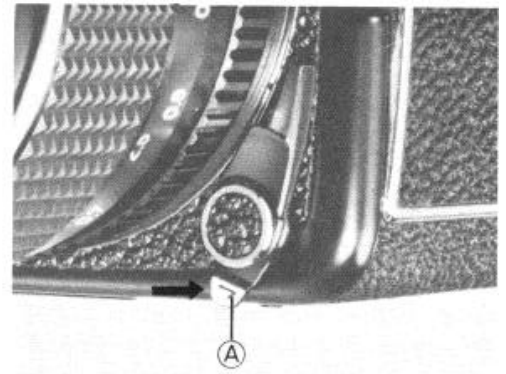

3. Push the activating lever in the direction of the engraved arrow to start the delayed shutter release.
4. The upper shutter release button will move when the delayed shutter release is activated. Do not advance the film until the upper shutter release button returns to its normal (raised) position.

*If desiring to stop the delayed shutter release after it has already started, merely reset the lever (14) and it will stop.

*Even after cocking the delayed shutter release, the shutter can be tripped

Interchanging the Film Advance Crank

● Removing the crank

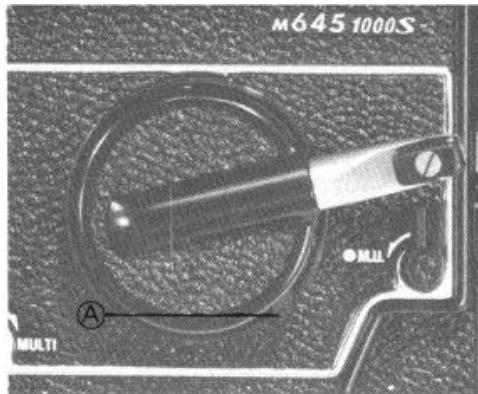

1. Rotate the film advance crank until it stops.
2. Then, rotate it counterclockwise approximately 20° while simultaneously pushing in on the release lever (A), and it will detach.

● Attaching the crank

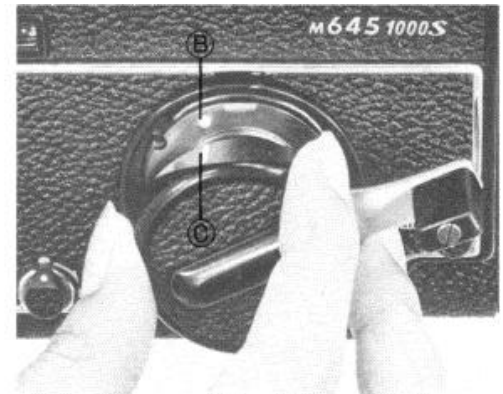

1. Align the red dot (B) of the camera body with the index line (C) on the film advance crank.
2. With red dot and index line aligned, push the film advance crank into the receptor, then twist approximately 20° clockwise while pushing in on the release lever (A), and it will lock into place.

with the Shutter release button, bypassing the delayed shutter release, as often as desired

*If the delayed shutter release is inadvertently started when the shutter is uncocked, it will stop after partially functioning. Then, reset the lever, advance the film, and push the activating lever to start the delayed shutter release. If the film is advanced, at such a time, before resetting the delayed shutter release, the delayed shutter release will automatically commence operating the moment the film is fully advanced, tripping the shutter a few moments later.

For the same reasons outlined above, the shutter release lock ring should also be set to the unlocked position before starting the delayed shutter release.

*When attaching the camera to a large, professional tripod, the camera support may protrude beyond the front of the camera body. However, if the camera is attached to such a tripod with the accessory Mamiya Quick-shoe model 2, it will be possible to cock the delayed shutter release with the camera attached to the tripod.

The film advance crank is interchangeable with the film advance knob which is available as an optional accessory.

● Attaching the knob

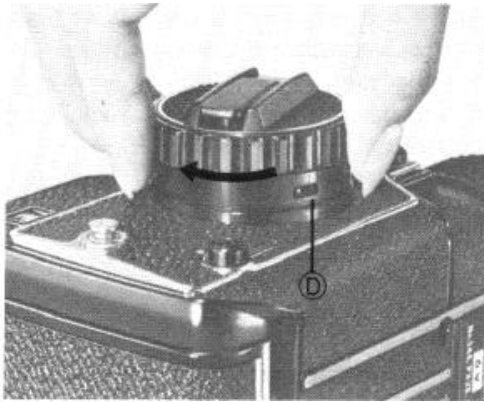

1. Rotate the film advance knob receptor of the camera body clockwise as far as it will go (the red dot (B) will then be facing upward).
2. With the release lever (D) of the knob at its lowest position, place knob against knob receptor of the camera body, rotating it clockwise approximately 20° and the knob will lock into place

● Removing the knob

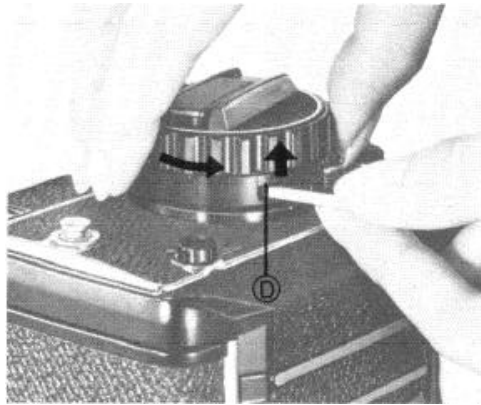

1. Rotate film advance knob until it stops.
2. While holding the release lever (D) of the knob in the up position with a small screwdriver, or suitable tool, rotate knob counterclockwise and it will disengage from camera body.

*When desiring to exchange the film advance crank or knob, first rotate it until it stops and the shutter is cocked. If this is not done, the camera body receptor [and red dot (B)] will freely rotate, making replacement difficult.

Tripod Socket

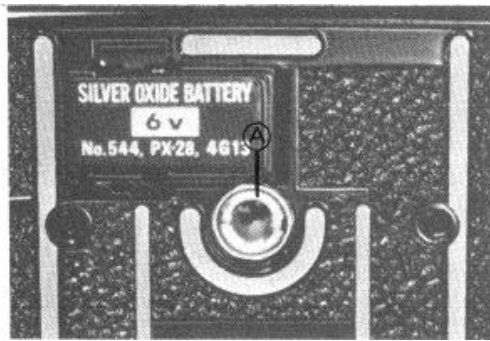

As a general rule of thumb for optimum sharpness, we recommend using 1/125 sec. as the minimum shutter speed for hand-held shooting. For longer exposures (1/60 sec. – 8 sec.), attach the camera to a sturdy tripod.

1. For standard tripods with a 1/4" screw, the camera may be directly attached to the tripod as it is.
2. To attach to tripods with the larger 3/8" screw, first unscrew the small screw found in the base of the camera's tripod socket by turning it counterclockwise. Next, remove the 1/4" adapter (A) by inserting a coin in the slot and turning the adapter in a counterclockwise direction. Finally, attach the camera to the 3/8" tripod.

* If it is necessary to completely eliminate all camera movement, attach camera to a tripod, lock the mirror up, and release the shutter with a cable release.

*When attached to the accessory Revolving Tripod Adapter, the Mamiya M645 can be instantly rotated to change from vertical to horizontal format, or vice versa.

Time Exposures

There are two methods of taking time exposures with the Mamiya M645.

1. By setting the shutter speed dial to B and using a cable release with lock provision.
2. By removing the battery from the battery chamber.
 - (a) Remove battery.
 - (b) Set the shutter speed dial to any position.
 - (c) Release the shutter and it will lock in the open position.
 - (d) Depress battery check button as far as it will go to close shutter.

Trouble-Shooting

If your camera appears to be malfunctioning, check the list below to see whether or not you have forgotten something.

1. The shutter release button will not move.

- A) Did you unlock the shutter release button? (p.30)
- B) Did you wind the film advance crank until it stops?(p.30)

2. The mirror is locked in the up position. (Cannot see anything through the finder.)

- A) Did you release the shutter without a battery in the camera? Has the battery been correctly inserted into the camera, or is it backwards? Is the correct battery type inserted into the camera?

Press the battery check button, as far as it will go, to lower mirror. (p.22)

- B) Did you lower the mirror lock-up lever? If so, raise it. (p.51)

- C) Did you release the shutter with the shutter speed dial set to the  position?

If so, move the shutter speed dial to B or 1/1000 sec, (p.28)

3. The developed roll of film has 1 or 2 frames less than it should have.

- A) Did you align the start marks with the film advance crank after placing the roll-film insert into the camera?

The film should always be set to the start mark before placing the film insert into the camera. (p.24)

- B) Did you properly align the start marks of the film and roll-film insert?

Check the instructions once again. (p.24)

4. The PD Prism Finder's LED's do not illuminate when pressing the meter switch.

Did you set the camera's shutter speed dial to the  position? If not, there will be no electrical connection. (p.35)

5. You may receive an electric shock when an electronic flash is connected to the X-sync terminal and you touch the hot-shoe. Also, you may receive an electric shock when an electronic flash is attached to the hot-shoe and you touch the X-sync terminal.

As a precaution against possible shock, always keep the safety cover on the terminal when not in use (see p.49)

Precautions

Releasing the shutter with no film in the camera

The film transport mechanism has a built-in safety lock which prevents the shutter from being released after the last exposure on a roll of film, or when there is no film in the camera. Thus, when the shutter release button locks under such circumstances, do not force it. To release the shutter, merely set the multiple-exposure lever to "MULTI".

Mirror Lock-up

When the mirror is locked in the up position and the camera is outdoors there is a small possibility of sunlight entering the lens, focusing on the rubberized-cloth focal plane shutter, and burning it to a certain degree. Although such a possibility is remote, caution is called for. Therefore, when using mirror lock-up outdoors, always return the mirror to its normal position after completing all your mirror lock-up exposures. If the interval between mirror lock-up exposures is long, lower the mirror while waiting.

The position on the Shutter Speed Dial

If the shutter is released with the shutter speed dial set to the  position, the mirror will lock in the up position and the film advance knob will not move. If the camera is left

in this condition the battery will lose its power within several hours.

The  position is only for use with the PD Prism Finder.

Photographing at Low Temperatures

When photographing at low temperatures, be careful of the following points to maintain camera performance.

1. Be sure to use a fresh battery.
2. When using electronic flash, set the shutter speed dial to 1/30 sec. or longer.
3. Place the camera in the outside air only during the moment of exposure.

*When working at extremely low temperatures, it sometimes becomes impossible to wind the film advance crank after the shutter has been released. In such a case, after placing the camera in a warm place, it will become possible to wind the film advance crank if the upper shutter release button is strongly depressed as far as it will go.

* A battery that malfunctions at low temperatures will become usable again when it is returned to normal temperature. However, the battery should not be subjected to rapid and extreme changes of temperature, lest it grow unreliable.

Care of the Camera

When the camera is not used for a long period of time, remove the battery and any film from the camera. Do not store the camera at temperatures exceeding 100°F (40°C) or at temperatures less than 15°F (-10%). Also avoid storing the camera for prolonged periods of time in a damp or salty atmosphere, (Color film should be stored at the manufacturer's recommended temperatures)

As cameras are precision instruments, avoid shocks and rough handling.

When the camera is stored for a long time, periodically remove the camera and release the shutter several times to keep the camera in good condition

Cleaning

Never touch the lens or mirror surfaces. Keeping a Mamiya UV or SL filter (p.61) on the lens will protect it from dust, fingerprints, and so on. If a lens needs cleaning, blow away the dust particles with a blower, and clean the lens surface with lens cleaning tissue and lens cleaner. Merely blowing dust particles off the mirror surface is sufficient- never touch it.

Periodic Check

Periodically check the camera to make sure it is in working order. This is especially so before an important photographic assignment. Check the battery, flash synchronization, mirror and shutter movement, film wind, diaphragm automation and so on. If the camera is malfunctioning, take it to the nearest authorized Mamiya Service Center for repairs.

Handled with reasonable care, your Mamiya M645 should provide you with years of pleasure.