

MT IE GB

# Instructions for use, installation, and connection



Combined freestanding cooker

# Combined freestanding cooker

---

## Dear customer!



We sincerely thank you for your purchase. We believe you will soon find ample evidence that you can really rely on our products. To make the use of the appliance easier, we attach these comprehensive instruction manual.

The instructions should aid you in getting familiar with your new appliance. Please, read them carefully before using the appliance for the first time.

These instructions are only valid if the country symbol is indicated on the appliance. If there is NO country symbol in the appliance, technical instructions should be observed for adapting the appliance to comply with the requirements and regulations for use in your country.

In any case, please make sure the appliance was supplied to you undamaged. Should you identify and transport damage, contact your sales representative or the regional warehouse from where the product was delivered. You will find the telephone number on the receipt or delivery report. We wish you a lot of pleasure with your new household appliance.

---

## Instructions for connection

The connection should be carried out in compliance with the instructions in the section "Connection to the power mains", and the relevant effective regulations and standards. This should only be performed by a qualified technician.

---

## Rating plate

Data plate indicating basic information on the appliance is located on the lower edge of the oven and it can be seen when the oven door is opened.

<b>Important - Read before using the appliance .....</b>	<b>3</b>
<b>Appliance description .....</b>	<b>6</b>
<b>Cooking surface .....</b>	<b>9</b>
<b>Operating the cooking zones .....</b>	<b>12</b>
<b>Operating the gas burners.....</b>	<b>13</b>
<b>The oven.....</b>	<b>15</b>
<b>Food preparation.....</b>	<b>21</b>
<b>Cleaning and maintenance .....</b>	<b>32</b>
<b>Special warnings and error reporting.....</b>	<b>40</b>
<b>Instructions for installation and connection.....</b>	<b>42</b>
<b>Nozzle table .....</b>	<b>49</b>
<b>Technical characteristics .....</b>	<b>51</b>

## Important - Read before using the appliance

### *Safety precautions*

- This appliance can be used by children aged from 8 years and above and persons with reduced physical, sensory or mental capabilities or lack of experience and knowledge if they have been given supervision or instruction concerning use of the appliance in a safe way and understand the hazards involved. Children shall not play with the appliance. Cleaning and user maintenance shall not be made by children without supervision.
- **WARNING:** The appliance and its accessible parts become hot during use. Care should be taken to avoid touching heating elements. Children less than 8 years of age shall be kept away unless continuously supervised.
- **WARNING:** Danger of fire: do not store items on the cooking surfaces.
- **WARNING:** Unattended cooking on a hob with fat or oil can be dangerous and may result in fire. Never try to extinguish a fire with water, but switch off the appliance and then cover flame with a lid or a damp cloth.
- Only use the temperature probe recommended for this oven.
- **WARNING:** Ensure that the appliance is switched off before replacing lamp to avoid the possibility of electric shock.
- Do not use harsh abrasive cleaners or sharp metal scrapers to clean the oven door glass since they can scratch the surface, which may result in shattering of the glass.
- Do not use steam cleaners or high-pressure cleaners to clean the cooking hob, as this may result in an electric shock.
- Before opening the cover, make sure it is clean and that there are now liquid residues on it. The cooker cover is lacquer coated and made of glass; it can only be closed once the cooking zones have cooled down completely. The symbol on the product or its packaging indicates that glass lids may shatter when heated. Turn off all the burners before lids may shatter when heated. Turn off all the burners before shutting the lid.
- The appliance is not intended to be controlled by external timers or special control systems.

## Warnings

- The appliance may only be connected by an expert authorized by the gas distribution company or an authorized service center. All relevant legislation and local gas distributor's technical conditions for connection to the gas mains should be complied with. Important notes on connection are provided in the chapter »Instructions for connection.«
- Unauthorized service and repair can result in risk of explosion, electric shock, or short circuit and consequently personal injury and damage to the appliance. Such tasks may only be carried out by an authorized expert.
- Before installing and connecting the appliance, make sure the local connection conditions and characteristics (gas type and pressure) are compatible with the appliance set-up.
- The set-up of the appliance is specified on the rating plate.
- The appliance is not connected to a flue or a ventilation opening. The appliance should be installed and connected in compliance with the relevant regulations on connection. Heat, moisture, and combustion by-products are released during the use of the cooking appliance in the room where it is installed. Make sure your kitchen is adequately ventilated, especially during the use of appliance. Open all natural ventilation openings or install a mechanical ventilation device (a mechanical kitchen hood).
- This is a class 2/14 appliance. The appliance may touch the adjacent cabinets on both sides when placed in a row. On one side, a tall cabinet – taller than the appliance – may be placed at a distance of at least 10 cm from the appliance. On the other side, only a cabinet of the same height may be placed.
- The vertical distance between the appliance and the kitchen hood must be at least 650 mm or at least the distance specified in the instructions for installation of the kitchen hood.
- If the power cords of appliances located near this appliance are caught in the oven door, they can be damaged, which may in turn result in a short circuit. Therefore, keep the power cords of other appliances at a safe distance.
- The appliance is intended solely for cooking. Do not use it for any other purpose, e.g. for room heating. Do not place empty cookware on the cooking zones.
- Pay attention to correct installation of burner parts.
- If you smell gas in the room, immediately close the main inlet valve on the gas cylinder or the gas grid, extinguish any fire (including cigarettes), ventilate the room, do not switch on any electrical devices, and call a natural gas expert.
- Also close the main inlet valve if you do not intend to use the burners for a longer period of time (e.g. before leaving on vacation).
- Be particularly careful when cooking food in the oven. Due to high temperatures, baking trays, baking sheets, the grid and the oven interior walls become very hot. Always use oven mitts.
- Do not line the oven walls with aluminium foil and do not place baking trays or other cookware on the oven bottom. Aluminium foil would prevent air circulation in the oven, hinder the cooking process, and ruin the enamel coating.
- Oven door become very hot during operation. A third glass is installed or additional protection to reduce the temperature of the outside surface (only with some models).
- Do not store combustible, explosive, volatile or temperature-sensitive items (such as paper, dish cloths, plastic bags, cleaners or detergents and spray cans) in the oven's storage drawer, as they can ignite during over operation and cause a fire. Only use the appliance storage drawer to store equipment (baking sheet, drip tray etc.).
- Oven door hinges may be damaged if overloaded. Do not place heavy cookware on the open oven door and do not lean against the door while cleaning the oven. Before cleaning the oven,

- remove the oven door (see chapter »Removing and re-installing the oven door«). Do not stand or sit on the open oven door (children!).
- Appliance operation is safe with and without tray guides.
  - In case of prolonged use of cast iron plates, the area of the plate and the edge of the cooking zone may discolour. Service in such case is not covered by the warranty.
  - The appliance is intended to be placed directly on the floor, without any supports or plinths.



**The symbol on the product or on its packaging indicates that this product may not be treated as household waste. Instead it shall be handed over to the applicable collection point for the recycling of electrical and electronic equipment. By ensuring this product is disposed of correctly, you will help prevent potential negative consequences for the environment and human health, which could otherwise be caused by inappropriate waste handling of this product. For more detailed information about recycling of this product, please contact your local city office, your household waste disposal service or the shop where you purchased the product.**

### ***Appliance purpose***

The appliance is intended for conventional preparation of food in households and should not be used for any other purpose. Individual options of use are comprehensively described in this instruction manual.

***If you notice any faults on the gas pipeline, or if you smell gas in the room:***

- Immediately shut down the gas supply or close the gas cylinder.
- Extinguish any flame, including cigarettes and other tobacco products.
- Do not turn on any electrical appliances (incl. the lights);
- Aerate the room thoroughly – open the windows!
- Immediately contact a service center or an authorized gas distribution company.

## Appliance description

The figure represents one of the appliance models. Since a group of appliances to which these instructions apply, have different features, the instruction manual may describe functions and equipment that may not be available in your appliance.



- 1 Cooking hob cover (only with some models)
- 2 Evacuation opening for combustions products and steam from the oven
- 3 Glass-ceramic cooking hob
- 4 Control panel
- 5 Oven handle
- 6 Oven door
- 7 Cooker drawer
- 8 Additional support (only with some models)
- 9 Adjustable feet; accessible when the cooker drawer is removed (only with some models)



- 1 Cooking hob cover (only with some models)
- 2 Evacuation opening for combustions products and steam from the oven
- 3 Glass-ceramic cooking hob
- 4 Control panel
- 5 Oven handle
- 6 Oven door
- 7 Cooker drawer
- 8 Adjustable feet; accessible when the cooker drawer is removed (only with some models)

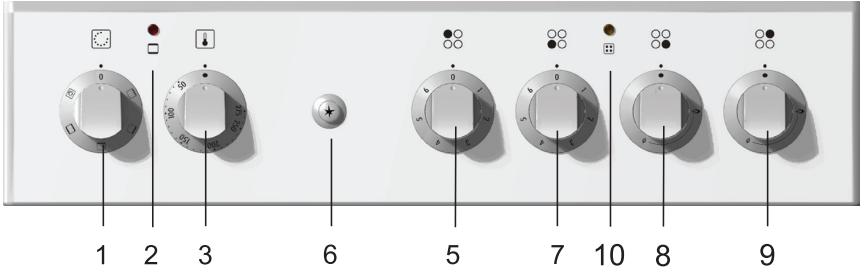
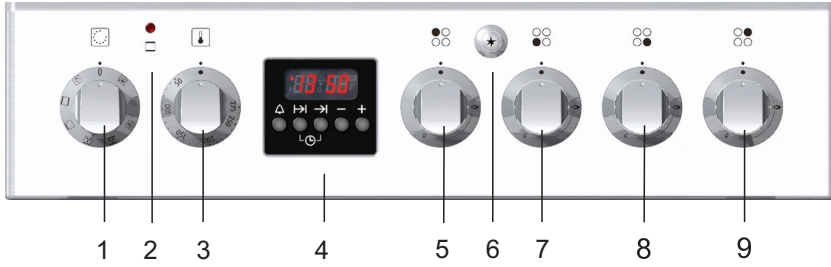

- |  |  |
|--|--|
| <ul style="list-style-type: none"> <li>1. On/off and operating mode selection knob</li> <li>2. Oven control light. It is on while the oven is heating up, and off when the set temperature has been reached</li> <li>3. Oven temperature selection knob</li> <li>4. Program timer (only with some models)</li> <li>5. Cooking zone knob, rear left, electric heater</li> </ul> | <ul style="list-style-type: none"> <li>6 Gas ignition button (certain models only)</li> <li>7. Cooking zone knob, front left, electric heater</li> <li>8. Cooking zone knob, front right, gas burner</li> <li>9. Cooking zone knob, rear right, gas burner</li> <li>10. Operation control lamp. It indicates that oven or one of the cooking zones is in operation.</li> </ul> |
|--|--|

### Electric ignition

(only with some models)

Gas cooking hob burners can be ignited using the electric ignition plug which is installed next to each burner. Electric ignition will only work if the mains cable is connected to the power supply network outlet. If the electric ignition is out of order due to a power supply failure or moist ignition plugs, burners can also be started using a match or a gas lighter. Oven burner is ignited in the same way.

(only with some models)

Before opening the cover, make sure it is clean and that there are now liquid residues on it. The cooker cover is lacquer coated and made of glass; it can only be closed once the cooking zones have cooled down completely.

The symbol on the product or its packaging indicates that glass lids may shatter when heated. Turn off all the burners before shutting the lid.

### Cooker cover



---

**Program timer  
(only with some models)**

---

Set the time of day as described in the separate instructions for the program timer, supplied with your appliance. Setting the time of day is requisite for the use of the appliance. Oven operation is only possible once the time of day has been set.

---

**Mechanical minute timer**

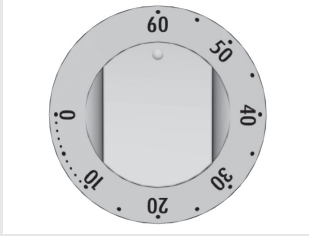

Maximum setting time is 60 minutes. After the set time has elapsed, an audible signal is emitted, lasting approximately five seconds. Select the countdown time roughly by rotating the knob forward in the clockwise direction; then rotate it in the other direction (anticlockwise) to fine-tune the setting.

---

**Switch-off timer - 120 minutes (timer switch)**

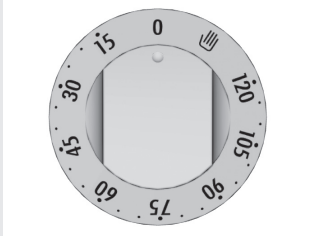

Switch-off timer enables settings from 0 to 120 minutes.

- Rotate the dial in the clockwise direction until the desired time is selected. After the set time has elapsed, the selected operation / heating mode is switched off.
- If you do not wish to use the switch-off timer, or if the preparation time is shorter than 15 minutes (preheating, preparing pizzas, etc.) or longer 120 minutes (for dishes that require a longer cooking time), the manual setting is recommended.
- For manual setting, rotate the knob to the left (anticlockwise) to the 👉 (hand) symbol. In the “0” position, the oven will not operate.



***Before using the appliance for the first time (depending on the model)***

## ***Important warnings***

### **A) Electric cooking zones**

- Switch on each **cooking zone** to the highest power level without any cookware on them for three to five minutes. During the first heating, the protective layer over the cooking hob may discharge some fumes. This way, the protective layer reaches its maximum solidness.
- Clean the **glass-ceramic** surface with a damp cloth and some manual dishwashing detergent. Do not use aggressive cleaners such as abrasive cleaning agents or sponges which may leave scratches, or stain removers.
- Do not switch on the cooking zones without any cookware on them and never use them for room heating!
- Make sure the cooking zones and the pan bottom are clean and dry; this will enable good heat transmission and prevent damage to the cooking zone.
- During cooking, the overheated fat or oil on the hob may ignite. Therefore, be careful when preparing food with fat or oil (e.g. French fries) and control the cooking process at all times.
- Do not place damp cookware or steam-covered lids on the cooking zones. Moisture is detrimental to the cooking zones.
- Do not leave a hot pan to cool down on the cooking zones, because moisture will be generated under it, causing corrosion.

### **Important warnings related to the glass-ceramic hob**

- The cooking zone will reach the selected power level or temperature very quickly; however, the area surrounding the cooking zones remains relatively cool.
- The hob is resistant to temperature changes.
- The hob is also impact-resistant. The pans may be placed onto the hob roughly without damaging the hob.
- Glass ceramic hobs should not be used as a worktop. Sharp objects can cause scratches.
- Preparing food in thin aluminum or plastic containers on hot cooking zones is not allowed. Do not place any plastic objects or aluminum foil on the glass ceramic hob.
- Never use a glass-ceramic hob that is cracked or broken. If an object falls on the hob with a sharp edge downwards, this could cause the hob / glass ceramic panel to break. The consequences are visible immediately, or only after a while. If any visible crack should appear, immediately disconnect the appliance from the power supply.
- If sugar is spilt on a hot glass ceramic hob, or a sugar-laden food, immediately wipe the hob.

## Cookware

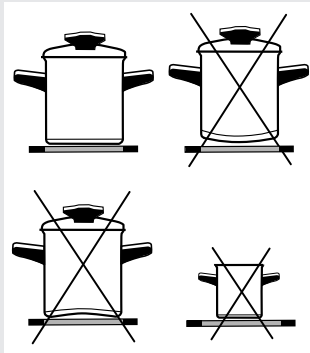

### Tips on the use of cookware

Use high-quality cookware with a flat and stable bottom.

- Transmission of heat is best when the pan bottom and the cooking zone are of the same diameter, and the pan is placed on the middle of the cooking zone.
- When using a tempered glass (Pyrex) or porcelain cookware, please follow the cookware manufacturer's instructions.
- When using a pressure cooker, do not leave it unattended until the desired pressure is reached. The cooking zone should initially be set to the maximum power level; as the pressure rises, use the sensors to decrease the power level according to the pressure cooker manufacturer's instructions.
- Make sure there is always enough water, either in a pressure cooker or in any other piece of cookware, as using an empty pan on the cooking hob will result in overheating which will damage both the pan and the cooking zone.
- Tempered glass (Pyrex) cookware with a specially brushed bottom is suitable for use on cooking hobs if it fits the diameter of the cooking zone. Cookware with larger diameter may break due to thermal stress.
- When using any special or unconventional cookware, follow the cookware manufacturer's instructions.
- When a highly reflective pan (bright metal surface) or a pan with a thick bottom is used for cooking on a glass-ceramic hob, cooking time can be extended by several minutes (up to 10 minutes). If you wish to boil a larger quantity of food, it is recommended to use a container with a flat dark bottom.
- Do not use clay cookware, because it may leave scratches on the glass-ceramic hob.

## Energy saving

- Pan bottom diameters should match the diameter of the cooking zone. If the pan is too small, some heat is wasted; furthermore, using a too small pan can damage the cooking zone.
- Whenever possible given the cooking process, use a lid.
- The pan should be appropriately sized given the quantity of food prepared. Preparing a small quantity of food in a large pan will cause a waste of energy.
- Dishes that take a long time to cook should be prepared in a pressure cooker.
- Various vegetables, potatoes, etc., can be cooked in a small quantity of water; however, the lid should be closed tightly. When the water is brought to boil, reduce the power level to a setting that maintains a temperature just above boiling point.

**Before using the  
appliance for the first time**

**Important warnings**

**B) Gas cooking zones**

No particular measures or procedures are required prior to the first use of a gas hob.

- For quick browning, set the burner to the maximum power initially, and then continue cooking with minimum power.
- With some models, gas burners are fitted with thermoelectric protection devices. If the burner flame is extinguished accidentally or unintentionally (e.g. when some liquid boils over or when there is draught in the room), gas supply is automatically cut off, thus preventing the gas to be emitted into the room.
- If the flame on a gas burner without thermoelectric protection is accidentally extinguished, the gas will be emitted into the room!
- Gas burner cover should always be placed very carefully on the burner crown. Make sure the slots on the burner crown are never obstructed.

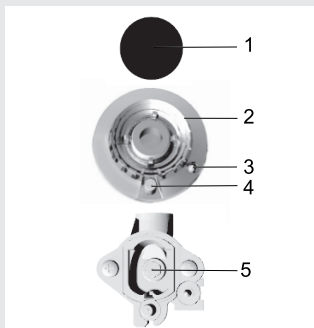

- 1 Burner crown cover
- 2 Burner crown with the support for the burner cover
- 3 Thermo-element (only with protected burners, available in some models)
- 4 Spark plug
- 5 Nozzle

**Cookware**

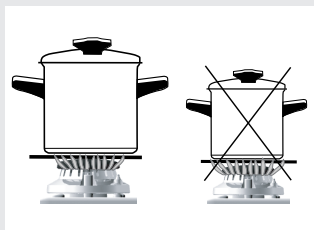

- Correctly selected cookware will enable optimum cooking time and gas consumption. Pan diameter is the most important parameter.
- Flames that reach over the edge of a pan that is too small, can damage the cookware; furthermore, gas consumption is higher in such cases.
- For combustion, the gas also needs air. If a pan is too large, air supply to the burner is insufficient; as a result, combustion effect is lesser.
- **Warning!** Any cookware (pots and pans) must be placed at least 15 mm away from the appliance edge to prevent excessive heating of the adjacent cupboard. Any adjacent cupboard may not be higher than the appliance top surface.

**Grid extension** (only available with some models)

Use the extension when using a pan of a smaller diameter. Place the extension on the grid above the auxiliary burner.

Burner type	Pan diameter
Large (3.0 kW)	220-240 mm
Normal(1.9 kW)	180-220 mm
Auxiliary (1.0 kW)	120-180 mm
Triple (3.5 kW)	220-240 mm

## Operating the cooking zones

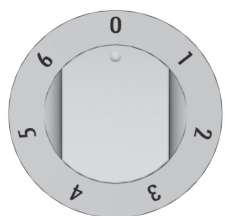
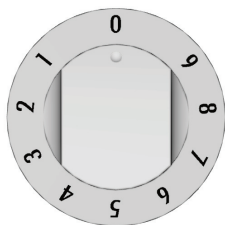

- Turn on the cooking zone using the knobs installed on the control panel.
- The symbol next to each knob indicates which cooking zone is operated by it.
- Cooking zone power level can be set continuously (1-9) or stepwise (1-6).
- The step knobs can be rotated in both directions. With continuous knobs, the power level is increased as you rotate them in the clockwise direction, and reduced as you turn them in the anticlockwise direction.
- The cooking zone may be turned off three to five minutes before the end of cooking in order to make use of the residual heat and save some energy (the following table lists some examples for using individual power levels).

S	E	
0	0	Cooking zone turned off; using the remaining heat
1	1-2	Maintaining the temperature and reheating of smaller quantities of food (minimum power)
2	3-4	Further cooking
3	5-6	Further cooking of larger quantities, further frying of larger pieces
4	7	Frying, preparing roux
5	8	Deep frying
6	9	Bringing to boil, browning, frying

**Rapid cooking zones** (only available in some models) differ from the conventional cooking zones by their maximum power which allows them to heat up faster.

**These cooking zones are indicated by a red dot in the middle; after a while, due to repeated use and cleaning, this dot may disappear.**

## Hi-Light cooking zones

Hi-Light cooking zones differ from the conventional zones by rapid heating; therefore, the cooking process begins very soon.



### Remaining heat indicator

Each cooking zone has a signal lamp which is lit whenever the cooking zone is hot. When the cooking zone cools down, the lamp goes off. The remaining heat indicator may be lit when a hot pan was placed on it, even if the cooking zone hasn't been used for a while.

## Operating the gas burners

### Control knob

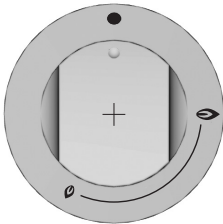

•	gas valve is closed
🔥	maximum power
🔥	minimum power

### Ignition and operation of the burners (depending on the model)

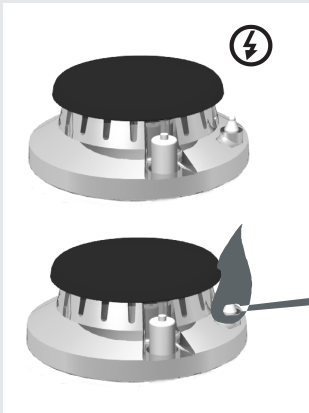

- Operate the gas burners using the knobs on the hob. Power levels are indicated on the knobs by large and small flame symbols (see section Appliance description).
- Rotate the knob through the large flame position (🔥) to the small flame position (🔥) and back. Operation interval lies between the two flame symbols.
- Gas burners can be ignited using the electric spark plug built into each gas burner (only available with some models).

**⚠ Before rotating the knob, it should first be depressed.**

### Single-handed ignition

- In order to ignite the gas burner, press the selected burner control knob and rotate it to the maximum power (flame) position. An electric spark will be generated automatically, igniting the releasing gas.
- If the electric ignition should not work due to a power failure or damp spark plugs, the gas can also be ignited using a match or a gas lighter.

### Two-handed ignition

- In order to ignite the gas burner, press the selected burner control knob and rotate it to the maximum power (flame) position. Then, press the ignition device button. An electric spark will be generated, igniting the releasing gas.
- If the electric ignition should not work due to a power failure or damp spark plugs, the gas can also be ignited using a match or a gas lighter. After igniting the gas, keep the control knob pressed for another ten seconds, until the flame settles.
- After ignition, keep the button depressed for the following 10 seconds, until the flame settles.
- The flame can then be set between the maximum and minimum level. Any setting between (🔥) and (●) is not recommended, as the flame is not stable in this interval and may be extinguished.



**If the burner hasn't ignited after the knob has been depressed for fifteen seconds, close the burner and wait at least one minute. Then, repeat the ignition process.**



**If the burner flame is extinguished (for any reason), close the burner and wait at least one minute before attempting to re-ignite it.**

- Note: While igniting the burners (applies to triple and double burner and the Mini Wok), the pans should already be placed on the grid over the burner.
- To extinguish the flame and close the burner gas supply, rotate the control knob to the right, to the 'OFF' position (●).

# The oven

## ***Before using the oven for the first time***

- Remove the sticker from the door glass before using the oven for the first time.
- Remove all accessories from the oven and clean them with warm water and a conventional detergent. Do not use abrasive cleaning aids.
- When the oven is heated up for the first time, a specific odor of a “new appliance” will be discharged; therefore, ventilate the room thoroughly while the oven heats up.

## ***Important warnings***

- Use dark, black silicon coated or enamel coated baking trays, as these transmit the heat particularly well.
- Only preheat the oven if specifically stated in the recipe or in the instruction tables herein.
- Heating up an empty oven uses a lot of energy; therefore, a lot of power is saved if several types of pastry are cooked consecutively, as the oven is already heated up.
- Approximately ten minutes before the anticipated end of the cooking process, the oven may be turned off. This way, you will save some power and make use of the accumulated heat.

## ***Operating the oven***

The oven is operated by the on/off and operation mode selection knob and the temperature setting knob / dial.

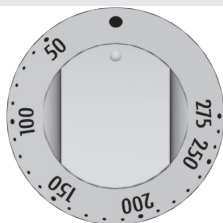

Temperature setting knob / dial

On/off and operation mode knob

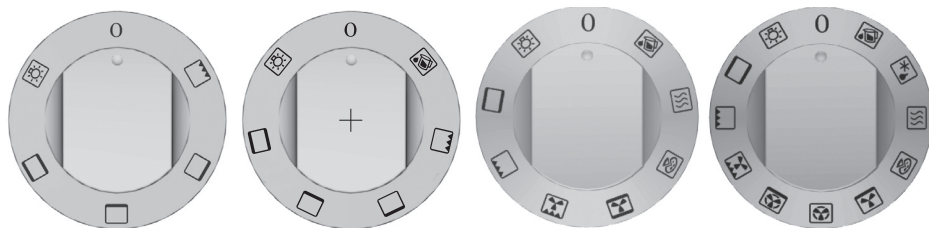

**The oven may be operated in the following modes**

 **Oven lighting**

With some models, there are two interior lighting lamps: one on the upper part of the back wall, and the other, additional lamp on middle of the right side wall. Oven lighting can be selected independently, without selecting another function. With all other modes of operation, the oven lighting is turned on automatically when the operation mode is selected.

 **Upper / lower heater**

The heaters on the upper and lower side of the oven radiate heat uniformly and evenly into the oven interior. Pastry and meat can be cooked on one shelf level only.



 **Grill**

In this cooking mode, the infrared heater is activated. The heat is radiated directly by the infra heater mounted on the ceiling of the oven cavity.

This cooking mode is appropriate for grilling smaller chunks of meat like steaks, sausage, fillets, cutlets etc.



 **Grill & fan**

With this operation mode, the infra heater and the fan are activated simultaneously. It is appropriate for grilling meat and large chunks of meat or poultry on one shelf level. Also appropriate for cooking food au gratin or browning.

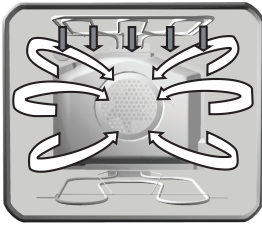

 **Hot air and lower heater**

In this cooking mode, the bottom heater and hot air fan are activated simultaneously. This combination is ideal for baking moist or heavy pastry, fruit cakes with leavened dough or short crust, and cheesecake.

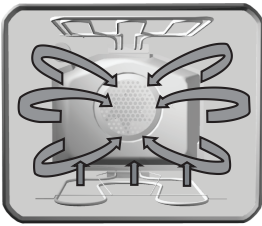



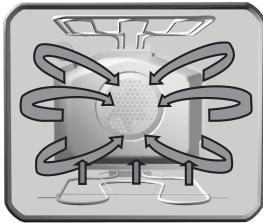

### »PIZZA SYSTEM«

This cooking mode is ideal for making pizza. Pizza is baked in a preheated oven at a temperature of 190 – 210°C for 15 – 25 minutes, depending on the size, in low baking sheet placed in the second guide level.

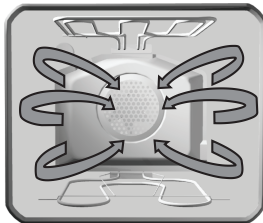

### Hot air

With this operation mode, the round heater and the fan operate simultaneously. The fan at the oven back wall causes the hot air to circulate constantly around a roast of pastry. This operation mode is appropriate for roasting meat and making pastry on several shelves simultaneously. Cooking temperature should be set lower than with conventional operation modes.

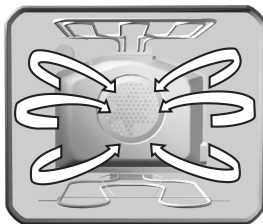

### Defrosting

With this mode, the air is circulating without any heater being turned on. Only the fan is in operation. This is used for slow defrosting or thawing of frozen food.

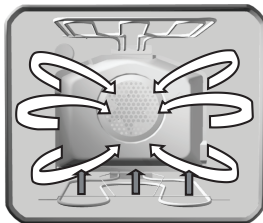

### Lower heater and fan

With this operation mode, the lower heater and the fan operate simultaneously. Used for baking low leavened dough and preserving fruit and vegetables. Use the first shelf position from the bottom and shallow rather than deep baking trays to allow the warm air circulate around the upper side of the dish as well.

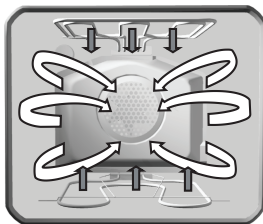

### Upper and lower heater plus the fan

The upper and the lower heater operate simultaneously. The fan enables uniform circulation of hot air in the oven. The system is suitable for making all kinds of pastry, for defrosting food, and drying fruit and vegetables. Before placing food into the preheated oven, wait for the signal lamp (heater operation lamp) to go off for the first time. For best results, cook on a single shelf level only; with cooking on two levels simultaneously, the results are somewhat inferior. The oven must be preheated. Use the second and fourth shelf level (from the bottom). The temperature should be set lower than with conventional heating combinations.



 **Lower heater / Aqua Clean**

The heat is only radiated by the heater installed in the bottom of the oven. Select this operation mode when you wish to bake / cook the bottom side of the dish more thoroughly (e.g. for moist pastry with fruit filling). Set the temperature with the temperature selection knob /dial. The lower heater can be used for cleaning the oven. Details are given in the “Cleaning and maintenance” section.



**Upper heater**

The heat is radiated only by the heater installed in the upper wall of the oven. Use this operation mode only when the upper side of the dish should be cooked more thoroughly (e.g. for additional browning).

 **Keeping warm**

(Place the food onto the support grid inserted in the second guide level.)

Use this function to reheat ready made food. Set the temperature dial to 70 °C. Reheating time is a matter of your choice, but make sure it is not too short, or the food will not be thoroughly reheated.

### ***Shelf levels (depending on the model)***

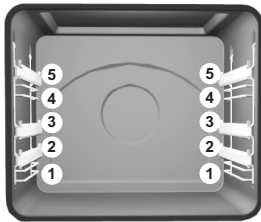
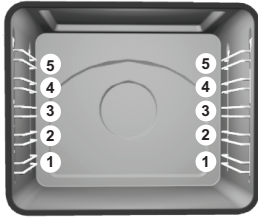
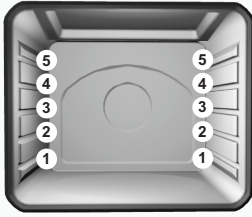

- Accessories (grid, shallow and deep baking tray) can be inserted into the oven at five levels.
- Please note that the shelf levels are always referred to by consecutive numbers starting from the bottom (particular shelf levels are described in the cooking tables below)
- The guides may be drawn, wire, or telescopic (depending on the appliance model). Telescopic (pull-out or, retractable) guides are installed for the second, third, and five level. In case of wire guides, the grid and the trays should always be inserted into the leading slot formed by adjacent wire profiles.

### ***Telescopic pull-out guides (depending on the model)***

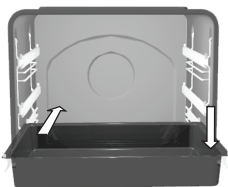
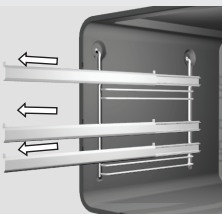

Telescopic (pull-out or, retractable) guides are installed for the second, third, and five level. They are installed on the left and right side wall of the oven interior at three levels.

Pull-out levels consist of (depending on the model):

- three guides that can be pulled out partially,
- one guide that can be pulled out completely and two that can be pulled out partially, or
- three guides that can be pulled out completely.



**Telescopic pull-out guides and other parts of oven accessories will heat up! Use a kitchen glove or similar protection when handling them.**

- To insert the grid, baking tray, or drip tray, first pull out the telescopic guides of the desired level.
- Place the grid or the shallow or deep baking tray on the pull-out guides and push it into the oven with your hand. Close the oven door only when the telescopic guides have been fully retracted.

**Oven accessories  
(depending on the  
model)**



The **glass tray** is intended for baking dishes, but may also be used as a serving tray.

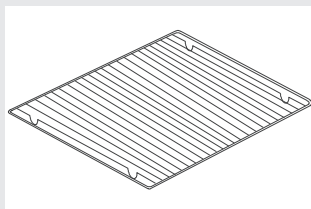

The **grid** onto which the container with food, or the food directly, is placed.

**⚠ A safety stop is fitted on the grid and on the guides.  
To pull out the grid, lift it slightly when it hits the stop.**

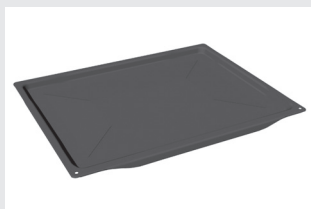

**Shallow baking tray** is only intended for baking pastry and cakes.



**Deep baking tray** is intended for baking meat and moist pastry; it is also intended as a drip tray.

**⚠ Unless you are using the grill, or the deep baking tray is used only as a drip tray when spit-roasting, the deep tray should not be inserted into the first guide.**



The oven interior ceiling is covered by a catalytic layer that can be installed or removed only by a qualified service technician.

### **Fat filter (depending on the model)**



The fat filter installed on the back oven interior wall protects the fan, round heater, and the oven from impurity, particularly spattering fat. When cooking meat, we recommend using the fat filter. When baking pastry, always remove the filter! If the filter is installed when baking pastry or cakes, the results can be quite poor.

## **Food preparation**

### **Baking pastry**

- For baking pastry, use the  or  mode of operation. (Oven operation with the selected mode, or system, depends on the appliance model).
- When baking pastry, always remove the fat filter.

#### **Instructions**

- When baking pastry, always observe the instructions on the shelf / guide level, temperature, and cooking time indicated in the pastry baking table. Do not be prejudiced by experience you may have with other ovens. The values indicated in the cooking table are defined and checked especially for this particular oven.
- If the baking table does not specifically address a particular type of pastry, see the information for a similar type of pastry.

#### **Baking pastry with upper and lower heater**

- Bake the pastry at one level only.
- Upper / lower heater combination is particularly appropriate for baking various types of pastry, bread, and meat.
- Use dark-colored baking trays. Light-colored trays reflect the heat, which leads to poorer cooking (browning) results.
- Always place the models on the grid. If you are using the supplied baking tray, remove the grid.
- Preheating will shorten the cooking time. Place the dish into the oven only when the selected temperature has been reached, i.e. when the control lamp (heater operation lamp) goes off for the first time.

#### **Baking pastry with hot air**

Baking pastry with hot air is particularly convenient when you wish to bake on several shelf / guide levels simultaneously, especially when preparing bite-size pastry in shallow trays. Preheating is recommended, and the use of the second and fourth guide level. This mode is also appropriate for moist pastry and fruit cakes (in this case, bake on a single level only).

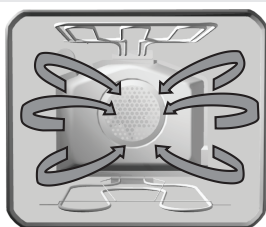

- The temperature is normally set lower than when baking with the upper/lower heater combination (see also the pastry baking table).
- Various types of pastry can be baked simultaneously, if the required temperature is at least approximately the same for all.
- Baking time can vary, even for equal baking trays. When baking in several baking trays simultaneously – on two or even three levels, baking time for each tray can be different. You may have to remove one of the trays sooner (normally, this would be the uppermost tray).
- If possible, prepare bite-size pastry, such as cupcakes, in the same thickness and height. Unevenly sized pastry will be unevenly browned!
- When baking several types of pastry simultaneously, there will be a significant amount of vapor in the oven, resulting in accumulation of condensate on the oven door.

### **Tips on baking pastry**

#### **Is the pastry completely done?**

Use a wooden stick to pierce the pastry at the highest point. If there are no traces of dough when the stick is removed, the pastry is done. Turn off the oven and use the remaining accumulated heat.

#### **The pastry has collapsed**

Check the recipe. Next time, use less liquid. Observe the instructions on mixing / kneading time, especially when using small household appliances.

#### **The pastry is too light-colored**

Next time, use a dark-colored baking tray, place the tray one guide level lower, or turn on the lower heater towards the end of the cooking process.

#### **The pastry with a moist filling (e.g. cheesecake) is not completely done**



Next time, reduce the temperature and extend the cooking time.

#### **Notes on the pastry baking table:**

- Two values are indicated for temperature, lower and upper. Initially, set the lower temperature; if the pastry is not brown enough, increase the temperature next time.
- Cooking times are given as an estimate and may vary subject to a number of circumstances.
- The value printed in bold in the temperature table indicates the most appropriate operating mode for a particular type of pastry.

- The indication \* means that the oven should be preheated with the corresponding operating mode selected.
- When using baking paper, make sure it is resistant to high temperature.

### Pastry baking table for combined upper and lower heater or hot air operating mode

Type of pastry	Guide (from the bottom)	Temperature (°C) 	Guide (from the bottom)	Temperature (°C) 	Cooking time (minutes)
<b>Sweet pastry</b>					
Marble cake, ring cake	2	160-170	2	150-160	55-70
Rectangle-shaped cake	2	160-170	2	150-160	60-70
Cake made in cake tin	2	160-170	2	150-160	45-60
Cake tin cheesecake	2	170-180	3	150-160	60-80
Fruit cake, short pastry	2	180-190	3	160-170	50-70
Fruit cake with dressing	2	170-180	3	160-170	60-70
Sponge cake*	2	170-180	2	150-160	30-40
Cake with icing	3	180-190	3	160-170	25-35
Fruit cake, mixed dough	3	170-180	3	150-160	50-70
Cherry cake	3	180-200	3	150-160	30-50
Sponge cake roll*	3	180-190	3	160-170	15-25
Leavened dough cake	3	160-170	3	150-160	25-35
Hefezopf (leavened dough)	2	180-200	3	160-170	35-50
Christmas cake	2	170-180	3	150-160	45-70
Apple pie	2	180-200	3	170-180	40-60
Oven-baked donuts	2	170-180	3	150-160	40-60
<b>Savory pastry</b>					
Quiche Lorraine	2	180-190	3	170-180	45-60
Bread	2	190-210	3	170-180	50-60
Buns*	2	200-220	3	180-190	30-40
<b>Bite-size pastry</b>					
Short pastry – cookies *	3	170-180	3	150-160	15-25
Merengue *	3	170-180	3	150-160	20-30
Leavened dough	3	180-200	3	170-180	20-35
Puff pastry	3	190-200	3	170-180	20-30
Choux pastry (cream filled)	3	180-190	3	180-190	25-45
<b>Frozen pastry</b>					
Apple, cheese pie	2	180-200	3	170-180	50-70
Cheesecake	2	180-190	3	160-170	65-85
French fries for oven *	2	200-220	3	170-180	20-35
Croquettes	2	200-220	3	170-180	20-35

**Note:** Guide number refers to the grid onto which smaller baking trays or cake tins are placed, and to shallow baking tray. The deep baking tray should not be inserted into the first guide.

## Settings table for baking pastry with hot air and lower heater

Type of pastry	Guide (from the bottom)	Temperature (°C) 	Cooking time (minutes)
Cheesecake (750g cheese) - short pastry	2	150-160	65-80
Quiche Lorraine - short crust dough	2	180-200	35-40
Apple pie with icing - leavened dough	3	150-160	35-40
Fruit cake - mixed dough	3	150-160	45-55
Apple pie - flaky pastry	3	170-180	45-65

## Pastry baking table for upper and lower heater with fan operating mode

Type of pastry	Guide (from the bottom)	Temperature (°C) 	Cooking time (minutes)
<b>Sweet pastry</b>			
Marble cake, ring cake	2	150-160	50-60
Rectangle-shaped cake	2	150-160	55-65
Cake made in cake tin	2	150-160	45-55
Cake tin cheesecake	2	150-160	65-75
Fruit cake, short pastry	2	150-160	45-65
Fruit cake with dressing	2	160-170	55-65
Sponge cake*	2	150-160	25-35
Cake with icing	3	160-170	25-35
Fruit cake, mixed dough	3	150-160	40-60
Cherry cake	3	150-160	30-40
Sponge cake roll*	3	160-170	15-23
Leavened dough cake	3	150-160	25-35
Hefezopf (leavened dough)	2	160-170	35-45
Christmas cake	2	150-160	45-65
Apple pie	2	160-170	50-60
Oven-baked donuts	2	150-160	35-45
<b>Savory pastry</b>			
Quiche Lorraine	2	170-180	45-55
Bread	3	170-180	50-60
Buns*	2	180-190	15-20
<b>Bite - size pastry</b>			
Short pastry - cookies	3	150-160	15-25
Merengue *	3	150-160	15-25
Leavened dough	3	160-170	18-23
Puff pastry	3	170-180	20-30
Choux pastry (cream filled)	3	170-180	25-45
<b>Frozen pastry</b>			
Apple, cheese pie	2	170-180	50-70
Cheesecake	2	160-170	65-85
Chips for oven*	2	170-180	20-35
Potato fries for oven	2	170-180	20-35

The indication \* means that the oven should be preheated with the corresponding operating mode selected.



- To cook meat, use the operating modes  and .
- Data printed in bold represent the most appropriate operation mode for a particular type of meat.
- When cooking meat, the use of the fat filter is recommended (depending on the model).

### Tips on using the cookware

- Meat can be cooked in enamel coated cookware, tempered glass (Pyrex) cookware, clay, or cast iron cookware.
- Stainless steel baking trays are less appropriate because they reflect the heat.
- If the roast is covered, it will remain juicier, and the oven will not be as dirty.
- In an open baking tray, the roast will brown sooner.

### Some notes on cooking meat

- The meat cooking table indicates recommended temperatures, guide/shelf level, and cooking time. Since cooking times depend strongly on the type, weight, and quality of meat, they may have to be adjusted.
- Cooking meat, poultry, and fish in an oven is economical only at weights exceeding 1 kg.
- When cooking meat, add enough liquid to prevent the fat and juices from the meat to be burnt onto the baking tray. This means that, in case of longer cooking times, the roast should be checked upon every one in a while, and liquid should be added.
- After approximately half of cooking time, turn the roast around, especially when baking in a tray. For better results, start the cooking with the upper side turned downwards.
- When cooking larger chunks of meat, condensate may accumulate on the oven door. This is a natural phenomenon which does not affect the operation of the appliance. After cooking, wipe the door and door glass dry.
- In order to prevent accumulation of condensate, do not let the dishes to cool down in the oven.

## Meat cooking table for upper/lower heater combination or with hot air

Type of meat	Weight (g)	Guide (from bottom)	Temperature (°C) □	Guide (from bottom)	Temperature (°C) ☼	Cooking time (min.)
<b>Beef</b>						
Beef roast	1000	2	200-220	2	180-190	100-120
Beef roast	1500	2	200-220	2	170-180	120-150
Roastbeef, medium done	1000	2	220-230	2	180-200	30-40
Roastbeef, well done	1000	2	220-230	2	180-200	40-50
<b>Pork</b>						
Pork roast, incl. skin	1500	2	180-190	2	170-180	140-160
Pork belly	1500	2	190-200	2	170-180	120-150
Pork belly	2000	2	180-200	2	160-170	150-180
Shoulder	1500	2	200-220	2	160-170	120-140
Pork roll	1500	2	200-220	2	160-170	120-140
Cutlet	1500	2	180-200	2	160-170	100-120
Minced meet roast (pork meat loaf)	1500	2	210-220	2	170-180	60-70
<b>Veal</b>						
Veal roll	1500	2	180-200	2	170-190	90-120
Veal joint	1700	2	180-200	2	170-180	120-130
<b>Lamb</b>						
Lamb loin	1500	2	190-200	2	170-180	100-120
Sheep joint	1500	2	190-200	2	170-180	120-130
<b>Venison</b>						
Rabbit loin	1500	2	190-210	2	180-190	100-120
Deer joint	1500	2	190-210	2	170-180	100-120
Wild boar joint	1500	2	190-210	2	170-180	100-120
<b>Poultry</b>						
Chicken, whole	1200	2	200-210	2	180-190	60-70
Chicken	1500	2	200-210	2	180-190	70-90
Duck	1700	2	180-200	2	160-170	120-150
Goose	4000	2	160-170	2	150-160	180-200
Turkey	5000	2	150-160	2	140-150	180-240
<b>Fish</b>						
Whole fish	1000	2	200-210	2	170-180	50-60
Fish soufflé	1500	2	180-200	2	150-170	50-70

**Warning:** The guide refers to the support grid. Place smaller baking sheets and trays onto the grid inserted in the first or second guide (never insert the deep baking tray into the first level guides).

- When grilling meat, you should be particularly careful. The high temperatures and infra heater heat the grid and other parts of the oven to very high degrees; use protective kitchen gloves and special meat tongs.
- Hot fat may squirt out of pierced meat (e.g. from sausages). To avoid burning your skin or eyes, use meat tongs.
- When grilling meat, control the process at all times. Due to high temperature, meat can be burnt quickly!
- Do not let children anywhere near the grill.
- Roasting with infra heater is recommended for crisp and low-fat preparation of grilled sausages, meat chunks, and fish (steak, chops, salmon fillets, etc.) or toasted bread, as well as for browning.

### **Some tips on using the grill function**

- When using the grill, oven door should always be closed.
- The cooking table for grilling indicates recommended temperature, guide level, and cooking time. Since cooking time depends strongly on the type, quality, weight, and quality of meat, it may have to be adjusted.
- When cooking meat, the use of fat filter is recommended (depending on the model).
- The infra heater (Large grill and Grill operating mode) should be preheated for five minutes.
- When cooking on a grid, spread some oil over it to prevent the meat from sticking onto it.
- Place thin slices of meat on the grid and insert it into the five guide level.
- Insert a baking tray, which will serve as a drip tray in this case, into the first or second guide level to collect the dripping fat and meat juices.
- Grilled meat should be turned halfway through the cooking. Cook the first side somewhat longer than the other one.
- When grilling larger chunks of meat on a grid (chicken, fish), insert the grid into the three level and the drip tray into the first level.
- Thinner slices of meat should only be turned once, while the thicker ones should be turned several times. Use meat tongs to turn the meat around, to prevent too much juice to be lost.
- Darker meat will brown better and sooner than pork or veal.
- After using the grill, clean the oven and accessories each time to prevent the dirt to be burnt onto the oven the next time you use it.





## Spit roasting

(only with some models)

- The rotating roast spit set consists of a rotating spit with a detachable handle and two forks with screws for fixing the meat chunk.
- When using the roast spit, first insert the special support frame into the fourth guide from the bottom.
- Spit the seasoned meat and stick the support forks into the meat chunk from each side to firmly fix it. Then, tighten the screws on the forks.
- Install the handle on the front part of the roast spit. Stick the pointed part of the spit into the opening on the right side of the back oven door, which is protected by a rotating shutter. Place the front part of the spit into the lowest part of the support frame until it snaps into place.
- Place the deep tray on the first or second level to function as a drip tray, catching the fat and juices dripping from the meat.
- Activate the grill by selecting the "grill"  mode.
- Before closing the oven door, detach the spit handle.
- The infra heater operation is controlled by a thermostat; also, it only works when the door is closed.

## Cooking table - Large grill

Type of food	Weight (g)	Guide level (from bottom)	Temperature (°C) 	Temperature (°C) 	Cooking time (min)
<b>Meat and sausages</b>					
2 beef loin chops, rare	400	5	230	-	14-16
2 beef loin chops, medium	400	5	230	-	16-20
2 beef loin chops, well done	400	5	230	-	20-23
2 pork neck chops	350	5	230	-	19-23
2 cutlets	400	5	230	-	20-23
2 veal steaks	700	5	230	-	19-22
4 lamb cutlets	700	5	230	-	15-18
4 grill sausages	400	5	230	-	9-14
2 pcs of meatloaf	400	5	230	-	9-13
1/2 chicken	1400	3	-	210-220	28-33 (1.stran) 23-28 (2.stran)
<b>Fish</b>					
Salmon slices	400	4	230	-	19-22
Fish in aluminium foil	500	4	-	220	10-13
<b>Toasted bread</b>					
6 slices white bread	200	5	230	-	1,5-3
4 slices of mixed flour bread	200	5	230	-	2-3
Toasted sandwich	600	5	230	-	4-7
<b>Meat / poultry*</b>					
Duck*	2000	1	190-210	150-170	80-100
Chicken*	1000	3	190-210	160-170	60-70
Pork roast	1500	3	-	140-160	90-120
Pork shoulder	1500	3	-	140-160	100-180
Pork joint	1000	3	-	140-160	120-160
Roastbeef / beef loin	1500	3	-	170-180	40-80

\* This type of meat can also be prepared on a roast spit (see instructions for spit roasting).

## Preservation

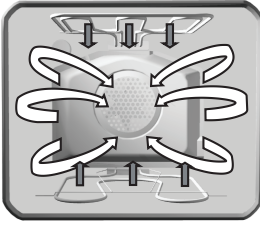

**For food preservation, use the lower heater + fan operating mode.**

Prepare the food to be preserved and the jars as usually. Use conventional jars with a rubber sealing and glass cover. Do not use jars with threaded or metal covers and metal cans / tins. Preferably, the jars should be of the same size, filled with the same type of food, and tightly sealed. Up to six one-liter jars can be placed into the oven simultaneously.

- Only use fresh food.
- Pour approximately one liter of hot water (about 70°C) into the deep baking tray to provide the required humidity level in the oven. Place the jars into the oven in such way that they are not in contact with the walls and each other (see figure). Rubber seals should be wetted before use.
- Insert the deep tray with the jars into the second guide level from bottom up. During preservation, observe the jars; cook until the contents of the jars starts to boil – bubbles appear in the first jar. Please note the cooking times from the preservation table below.

### Preservation table

Food to be preserved	Quantity	 T=180°C, until boiling / bubbling (min.)	After appearance of bubbles	Standing time (in the oven (min))
<b>Fruit</b>				
Strawberries	6x1 liter	approx. 30	turn off	25
Stone fruit	6x1 liter	approx.30	turn off	30
Apple puree	6x1 liter	approx.40	turn off	35
<b>Vegetables</b>				
Sour gherkin	6x1 liter	approx. 30 do 40	turn off	30
Beans, carrots	6x1 liter	approx.30 do 40	Set to 130°C 60 - 90 min	30

**Durations:** given in the chart are approximate only. Actual time may vary due to differences in room temperature, number of jars, quantity and temperature of the fruit and vegetables to be preserved, etc. Before turning off the oven (for fruit) or setting a lower temperature (for some types of vegetables), make sure there are actually visible bubbles in the jars.

Important: Observe carefully when the bubbles appear in the first jar.

## Defrosting

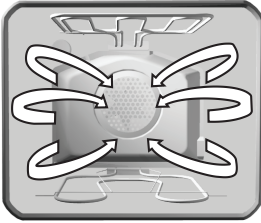

- Air circulating in the oven may speed up the process of defrosting frozen food. To do this, set the oven to “Defrosting” mode.

**⚠ If the temperature setting button is accidentally activated, the oven control lamp will light up, but the heaters will not be activated.**

- Food appropriate for defrosting includes cakes with heavy cream or butter-based filling, other cakes and pastry, bread, buns, and deep-frozen fruit.
- For reasons of hygiene, meat and poultry should not be defrosted in an oven.  
If possible, turn the food around or mix several times to make sure they are defrosted evenly.

# Cleaning and maintenance

Do not use a steam cleaner or a high-pressure steam cleaner to clean the appliance. Before you start cleaning the appliance, disconnect it from the power mains and let it cool down.

## Appliance housing front

Clean the surfaces with liquid non-abrasive detergents intended for smooth surfaces, and a soft cloth. Apply the detergent on the cloth and wipe off the dirt; then, rinse with water. Do not apply the detergent directly on the surfaces. Do not use aggressive or abrasive cleaners, sharp objects or steel wool, as these will scratch the appliance.

## Aluminum surfaces

Aluminum surfaces should be cleaned with non-abrasive liquid detergents intended for such materials. Apply the detergent on a wet cloth and clean the surface; then, rinse the surface with water. Do not apply the cleaner directly on the aluminum surface. Do not use abrasive cleaners or abrasive sponges. The surface should not come into contact with oven cleaning sprays.

## Stainless steel front panels

(only with some models)

Clean the surface with a mild cleaner (soapsuds) and a soft sponge that will not scratch the material. Do not use abrasive or solvent-based cleaners. If these instructions are ignored, the housing surface can be damaged.

## Lacquer-coated and plastic surfaces

(only with some models)

Clean the buttons / knobs and the door handle with a soft cloth and liquid detergents intended for cleaning smooth lacquer-coated surfaces. You may also use the cleaners made especially for this type of surfaces; in this case, follow the manufacturer's instructions.

**WARNING:** The above surfaces should never come into contact with oven cleaning sprays, as these will permanently damage the aluminum parts.

## Cleaning

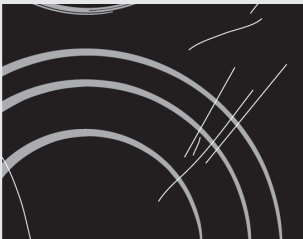

Figure 1

After each use of the **glass-ceramic hob**, wait for it to **cool down** and clean it; otherwise, even the smallest food residue will be burnt onto the hot surface next time you use the appliance.

**For regular cleaning and maintenance of the glass-ceramic surface, use special conditioning agents** which form a protective layer on the surface, shielding it from dirt. Before each use, wipe any dust or other particles from the hob surface and pan bottom as these could scratch the surface (Figure 1).

**Careful:** steel wool, abrasive sponges, and abrasive detergents can scratch the hob surface. Glass ceramic surface can also be damaged by aggressive sprays and inappropriate or insufficiently shaken (mixed) liquid cleaning agents (Figure 1 and Figure 2).

**Signage** may be worn when using aggressive or abrasive cleaners or cookware with damaged bottom (figure 2).



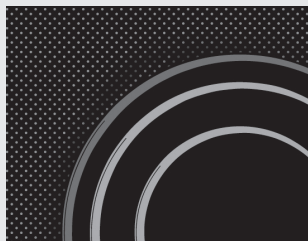

Figure 2



Figure 3



Figure 4

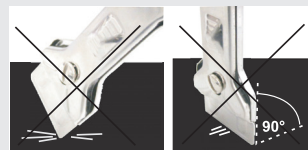

Figure 5

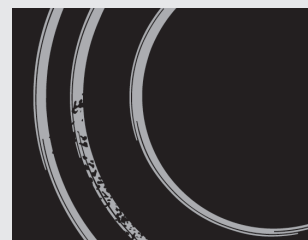

Figure 5

**Light stains** can be removed by a damp soft cloth; then, wipe the surface dry (Figure 3).

**Water stains** can be removed using a mild solution of vinegar; however, do not use this solution to clean the frame (only with some models, as it may become dull. Do not use aggressive sprays or decalcification agents (Figure 3).

**Heavier stains** can be removed using special agents and utensils for cleaning the glass-ceramic hobs. When using these products, follow the instructions provided by their respective manufacturers.

**Make sure any residues of cleaning agents are thoroughly removed, as they could damage the glass-ceramic hob when the cooking zones heat up** (Figure 3).

Remove stubborn and burnt residues with a scraper (figure 4). Be careful when handling the scraper to prevent injury.



**Only use the scraper when dirt cannot be removed with a wet cloth or special cleaners for glass ceramic surfaces.**

Hold the scraper at the **correct angle** (45° to 60°). **Gently press the scraper** against the glass and slide it over the signage to remove the dirt. Make sure the plastic handle of the scraper (in some models) does not come into contact with a hot cooking zone.



**Do not press the scraper perpendicularly against the glass and do not scratch the hob surface with its tip or blade.**

Sugar and sugar-laden food may permanently damage the glass-ceramic surface (Figure 5); therefore, they should be removed from the glass-ceramic surface as soon as possible, although the cooking zone may still be hot (Figure 4). **Any change in the color of the glass-ceramic surface** does not affect its operation or the stability of the surface. Such discolorations are mostly a result of burnt food residues or use of cookware made of materials such as aluminum or copper; these stains are difficult to remove.

**Warning:** All damage described above predominantly relates to the aesthetics, i.e. appearance of the appliance and do not affect its functionality directly. Such errors cannot be the subject of a warranty claim.

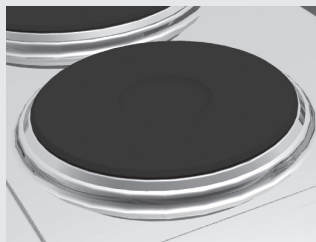

### Cooking hob

- Use warm water with some dishwashing detergent to clean the area **around the cooking rings** (or hotplates). Before doing so, use a sponge to soften any stubborn residues.
- Dirty cooking zones should be cleaned thoroughly immediately after use. If the cooking zones are less stained, it suffices to wipe them with a damp cloth soaked in water and some detergent. If the hotplate is heavily soiled, use a steel sponge (wire scrubber) soaked with detergent. After cleaning, the cooking zones should always be wiped dry.
- Salt-containing liquids, dishes that have boiled over, or moisture, can damage the cooking zones. Therefore, always wipe the cooking zones clean and dry.
- To **condition the cooking zones**, occasionally use some sewing machine oil, or conventional products for cleaning and care, available in the market. Never use butter, bacon / lard, or similar substance (risk of corrosion). If the cooking zone is slightly warm, the detergent will penetrate the pores more quickly.
- **Hotplate rings are made of stainless steel**; due to thermal load during cooking, they may discolor slightly to yellow. This phenomenon is a result of physical processes. Yellow spots can be restored by conventional metal cleaning detergents. Do not use aggressive utensils for cleaning the dishes, as these will scratch the rings.

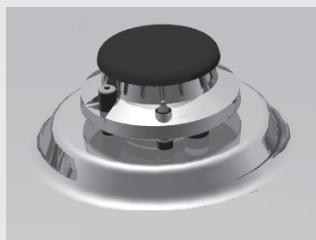

### Gas cooking zones

- To clean the grid, cooking hob surface, and parts of the burner use hot water with some dishwashing detergent. Do not clean in a dishwasher.
- Clean the thermo-element and the spark plug with a soft brush. These parts must be kept impeccably clean, as only then will they operate correctly.
- Clean the crown and the burner cover. Be particularly careful to keep all exit slots on the crown clean and unobstructed.
- After cleaning, dry all parts thoroughly and replace or reassemble them correctly. Parts that are placed askew will make lighting the burners more difficult.

**Warning:** Burner covers are coated in black enamel. Due to high temperatures, discoloration is unavoidable; however, this will not affect the operation of the burners.

### Oven

- The oven can be cleaned in conventional manner (with detergents, oven spray), but only when there is very dirty and when the stains are particularly stubborn.
- For regular cleaning of your oven (after each use), the following procedure is recommended: rotate the operation mode selection knob to the position . Set the temperature selection knob / dial

to 70°C. Pour 0.6 liter of water into a baking tray and insert it into the lowermost guide. After thirty minutes, the food residues on the enamel will have softened, allowing you to wipe them with a damp cloth.

**When dealing with stubborn stains, please not the following:**

The oven should be cooled down before each cleaning process.

- Clean the oven and accessories after each use to prevent the dirt from being burnt onto the oven.
- The easiest way to remove grease is by using warm soapsuds while the oven is still warm.
- In case of particularly stubborn dirt, use the conventional oven cleaners. Then, rinse the oven thoroughly with clean water to remove all residues of the cleaner.
- Never use aggressive cleaners such as steel wool, abrasive dishwashing sponges, stain removers, etc.
- Lacquer-coated, stainless steel, and zinc-coated surfaces, as well as aluminum parts, should never come into contact with oven cleaning sprays, as these may cause damage and discoloration. The same applies for the thermostat sensor (if the cooker features a timer with a probe) and the heaters accessible at the upper part.
- When purchasing and dispensing detergents, consider the environment and observe the instructions provided by respective cleaning agent manufacturers.

**Catalytic layer (only with some models)**

- Catalytic enamel is soft and sensitive to mechanical stress; therefore, the use of abrasive cleaners and sharp objects is not recommended.
- Coarse catalytic enamel speeds up the disintegration of grease and other types of impurity. Minor stains that remain after cooking normally disintegrate by the time the oven is used for the next time. In general, the stains will disappear at temperatures above 220°C, while with lower temperatures they will disappear only in part.
- Self-cleaning power of the catalytic parts is weakened in time. We recommend replacing the layer after a few years of regular use.

**Practical tip**

- When cooking larger fatty chunks of meat, we recommend wrapping them in aluminum foil or a suitable cooking bag, to prevent the grease from being splattered on the oven interior walls.
- When grilling meat on the grid, place a drip tray underneath.

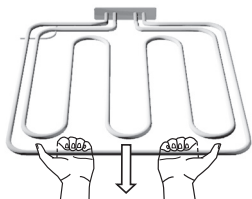

### **Cleaning the oven interior ceiling (only with some models)**

- To facilitate cleaning of the oven interior upper wall, some appliances feature a foldable upper infra heater.
- Before lowering the heater, the cooker must be disconnected from the power mains by removing the fuse or tripping the main switch.
- The heater should be cooled down; otherwise there is a risk of burning!
- Do not use the heater when it is lowered!

Before cleaning the oven, remove the baking trays, the grid, and the guides. Then, pull the horizontal heater towards yourself. Pull the heater until the crossbar is released from the supports on the left and right side of the oven (see figure). After cleaning, replace the heater following the same procedure; the crossbar must be reinserted into the two support brackets.

### **Accessories**

Wash the accessories (baking trays, grid, etc.) with hot water and some conventional detergent.

### **Grease filter (only with some models)**

After each use, clean the grease filter with a soft brush in hot water and some detergent, or wash it in a dishwasher.

### **Special enamel coating**

The oven, interior side of the door, and baking trays, are covered with special enamel that has a smooth and resistant surface. This special layer enables easier cleaning at room temperature.

### **Maintenance (depending on the model)**

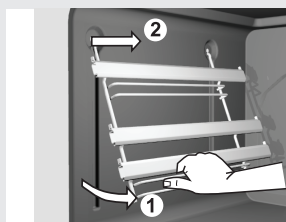

### **Removing the telescopic pull-out guides**

To facilitate cleaning of the oven interior side walls, the telescopic pull-out guides can be removed

- Hold the guide rack by its lower end and rotate it inwards; then, remove them from the holes on the upper side.
- Clean the racks with telescopic guides only with conventional cleaners.
- Do not wash the telescopic pull-out guides in a dishwasher.

**⚠ Do not attempt to grease the telescopic retractable guides.**

After cleaning, simply replace the guide rack by following the procedure in reverse order.

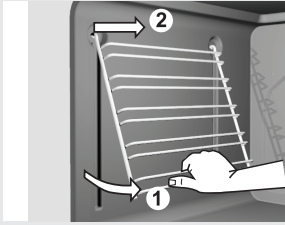

### Removing wire guide racks

To facilitate cleaning of the oven interior side walls, the wire guide rack can be removed.

- Hold the guide rack by its lower end and rotate it inwards; then, remove them from the holes on the upper side.
- Clean the guide racks guides only with conventional cleaners.
- After cleaning, simply re-hang the guide rack in the holes provided and pull the downwards.

### REMOVING INSIDE DOOR GLASS – APPLIES TO PREMIUM FULL-GLASS DOOR

Door glass can also be cleaned from the interior side; however, door has to be removed first (see section on removing and replacing the oven door).

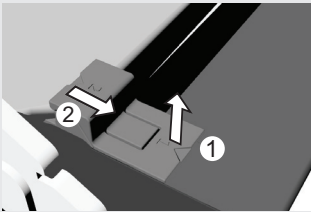

figure 1

- Slightly lift the supports on the left and right side of the door (marking 1 on the support) and pull them away from the glass (marking 2 on the support) (see Figure 1).

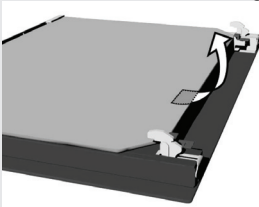

figure 2

- Hold the door glass by the lower edge, slightly lift it so that it is no longer attached to the support, and remove it (Figure 2).

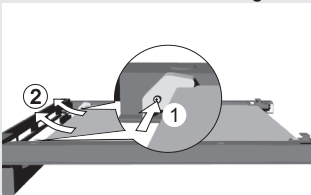

figure 3

- To remove the third inside glass (only with some models), undo the screws on the rubber on the left and right side (Figure 3). Remove the glass (in the direction of the arrow 2).

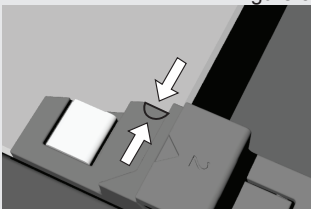

figure 4

- To replace the door, observe the reverse order.

**Note: To replace the glass, make sure the markings (crescent) on the door and the glass are aligned (Figure 4).**

## REMOVING AND REPLACING THE OVEN DOOR WITH A SINGLE-AXIS HINGE (depending on the model)

a) Conventional closing

b) **GentleClose** – the system absorbs the shock from door closing.

It allows simple, quiet, and smooth closing. A gentle push (to a 15° angle relative to the closed door position) is enough for the door to close automatically and softly.

**⚠ If the force applied to close the door is too strong, the effect of the GentleClose system is reduced or the system will be bypassed for safety.**

- Fully open the oven door and rotate the stoppers all the way back – applies to conventional door closing (Figure 1).

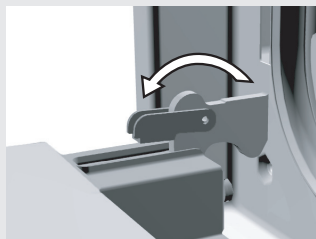

figure 1

- With **GentleClose** door system, rotate the stoppers back by 90°(Figure 2).

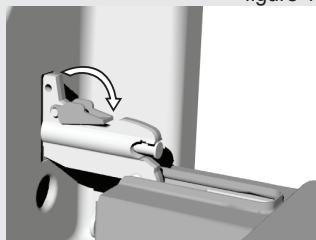

figure 2

- Slowly close the door until the clips are pressed against the supports / seats. At approximately 15° (relative to the closed door position), pull the door slightly upward and pull them out of the both hinge supports on the appliances (Figure 3).

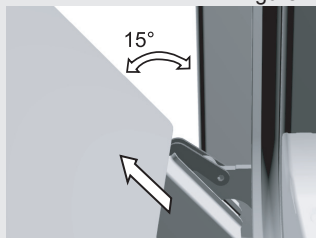

figure 3

- Replace the door in the reverse order. Insert the door under an angle of 15° into the hinge supports at the front side of the appliance and push them downwards and to the front until they slide into their supports / seats.
- Then, completely open the door and rotate the attachment clips back to their initial position. Slowly close the door and check, if they close properly. If the door does not open or close correctly, make sure whether the hinge notches are correctly placed in their seat hinges.

### Attention

Always make sure the hinge attachment clips are firmly seated in their supports when installing the door. If this is not the case, the main hinge that is operated by a strong spring may be released any time while installing or removing the door. Risk of physical injury.

## Cooker drawer

- Cooker drawer is protected against accidental opening. If you wish to open the drawer, raise it slightly. In order to remove the drawer, first pull it out to the stopper, then raise it again and pull it out completely.
- Do not store flammable, explosive, or temperature-sensitive objects and materials in the cooker drawer.
- With some appliances, the drawer is inserted by inserting the lower back slider into the guide on the cooker. If the cooker drawer is fitted with side guides with wheels, insert it by inserting the wheels into the guides and close the drawer.

## Door lock (only with some models)

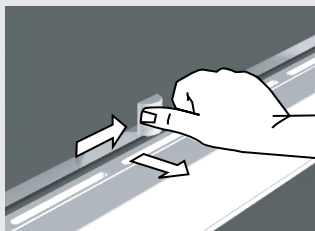

- Oven door is fitted with a door lock that prevents it from being open until the lock is released. Door lock is opened by a slightly pressing your thumb to the right and simultaneously pulling the door outwards.
- When the oven door is closed, the door lock automatically returns to its initial position.

**Note:** If the door lock is supplied with the appliance, attach it under the appliance control panel in compliance with the instructions for installation, which are supplied with the lock.

## Replacing appliance parts

**The oven lamp base and socket are under voltage. There is a risk of electric shock!**

Before replacing the oven lighting bulb, disconnect the cooker from the power mains by removing the fuses or tripping the main network switch.

### Oven bulb

(only with some models)

Oven bulb is considered a replacement ware part and is not covered by the warranty. Replace the bulb with a new one with the following specifications: socket E 14, 230 V, 25 W, 300°C.

- Unscrew the glass cover in the counterclockwise direction, replace the bulb, and replace the cover.

Bulb lamps used in this appliance are special purpose lamps selected for household appliances use only. They are not suitable for household room illumination.



## Special warnings and error reporting

**During the warranty period, any repairs may only be performed by service technicians authorized by the appliance manufacturer.**

Before starting the repair, the appliance must be disconnected from the power mains by removing the fuse or by removing the mains cord from the wall outlet.

Unauthorized tampering and repairs may cause the risk of electric shock and short circuit; therefore, do not attempt them yourselves. Leave such tasks to an expert or an authorized service technician.

In case of minor faults or problems with the appliance operation, check the following instructions to see whether you can eliminate the causes by yourselves.

### **Important**

A visit by a service technician during the warranty period will be charged if the appliance is not functioning because of improper use. Store these instructions in a place where they are always readily accessible; if pass the appliance on to another person, the instructions should also be included.

Following is some advice on rectifying some common problems.

The main fuse is tripped repetitively	<ul style="list-style-type: none"><li>• <b>Call a service technician!</b></li></ul>
Oven interior lighting does not work	<ul style="list-style-type: none"><li>• <b>The process of replacing the bulb is described in the section “Appliance part replacement”.</b></li></ul>
The oven does not heat up...	<ul style="list-style-type: none"><li>• Was the temperature and operating mode selected appropriately?</li><li>• Is the oven door closed?</li></ul>
The pastry is not cooked thoroughly...	<ul style="list-style-type: none"><li>• Have you removed the grease filter?</li><li>• Did you observe the instructions and tips from the section “Baking pastry”?</li><li>• <b>Did you follow the instructions in the baking table closely?</b></li></ul>
Program timer display is blinking	<ul style="list-style-type: none"><li>• There was a power supply failure, or your cooker was just connected to the power mains. All set times have been deleted.</li><li>• Set the time of day to enable operation of the appliance.</li><li>• After the end of program timer controlled operation (automatic operation), the oven goes off, the time of day is displayed, and an audible signal is emitted for a certain period of time. Take the dish out of the oven, return the operation mode selection knob and the temperature knob/dial back to the starting position. Select the “Manual mode” function to be able to use the oven in the conventional way (without the program timer).</li></ul>
Operation control lamp is not lit...	<ul style="list-style-type: none"><li>• Did you activate all necessary controls?</li><li>• Did the main fuse in your home network trip?</li><li>• Are the temperature knob /dial and the operating mode selection knob set properly?</li></ul>



<b>The flame is uneven / unstable</b>	Have an expert check the gas pipeline!
<b>The flame from the burners suddenly changes</b>	Assemble the burner correctly.
<b>The flame is extinguished shortly after ignition</b>	<ul style="list-style-type: none"> <li>• Keep the knob depressed for a longer period of time.</li> <li>• Before releasing it, pres it harder.</li> </ul>
<b>The grid has discolored in the burner area?</b>	Clean the grid with a metal care detergent.
<b>Electric ignition of the burners no longer works?</b>	Check the fuse in the fuse box and replace it if it is blown.

If the problem persists despite observing the instructions above, call an authorized service technician. Elimination of any errors or warranty claims that resulted from improper connection or use of the appliance is not covered by our warranty. In such cases, the costs of repair are borne by the user.

# Instructions for installation and connection

## ***Important warnings***

- The appliance may only be connected by a service technician authorized by the gas distribution company or an authorized service center.
- The room in which the appliance is installed must be regularly ventilated.
- Gas type that the appliance is adjusted to by the manufacturer is indicated on the rating plate.
- Before connecting the appliance, make sure that the local requirements for connection (gas type and pressure) are compatible with the appliance version / adjustment.
- This appliance is not connected to a combustion fumes exhaust system (i.e. a chimney). The appliance must be installed and connected in compliance with the relevant effective installation regulations. Special care must be taken to ensure adequate ventilation / aeration.
- The distance between the cooking hob and the kitchen hood should be no less than indicated in the instructions for kitchen hood installation.
- This appliance is appropriate for installation between two pieces of furniture (class 2/1); it can be in direct contact with them on both sides. On one side of the appliance, a piece of kitchen furniture that is higher than the appliance may be installed, if the distance between the appliance and this piece of furniture is not less than 10 centimeters. In such case, only a piece of furniture with a height not exceeding that of the cooker may be installed on the other side of the appliances. Hanging, or wall-mounted kitchen elements should be installed high enough not to interfere with the work process. The distance between the cooking hob and the kitchen hood should be no less than 650 mm.
- If the gas used in your pipeline is not compatible with the current appliance adjustment, call a service center or a gas distribution company. Their experts will adjust the appliance to be compatible with the gas type in your pipeline quickly and professionally.
- All other repairs and similar tasks that require the use of any tool whatsoever should only be carried out by an authorized service technician.
- The user may only perform those tasks that can be carried out without the use of tools.
- The walls and furniture closest to the appliance (floor, kitchen back wall, side walls) should be resistant to temperatures of at least 90°C.
- Mains cord on the back side of the appliance must be secured in such way that it is not in direct contact with the cooker back wall, as this wall heats up considerably during operation.

## Installation of the appliance

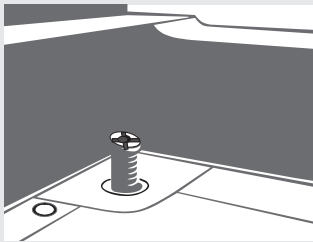
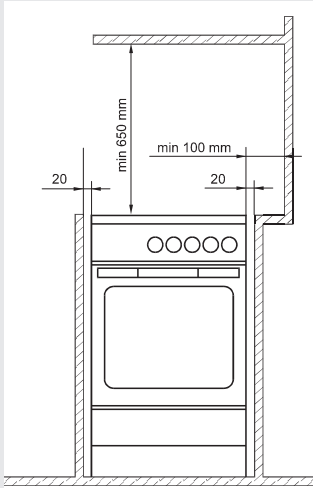

Appliance is classified in class 1 and class 2/subclass1. It must be installed in such way to leave a minimum of 20 mm distance from adjacent elements. On one side it may be placed adjacent to a higher element. In such case the distance from the appliance must be at least 100 mm. Height of the element placed on the opposite side must not exceed the height of the appliance. Distance between the appliance and the kitchen hood must be such as indicated in the instruction for the installation of the hood. Vertical distance between the appliance and suspended kitchen cabinet must not be less than 650 mm. Adjacent walls or kitchen cabinet panels (floor, surrounding walls) must be made from temperature resistant materials of at least 100°C.

### Leveling the cooker and additional support

The height of the cooker, including the support, is 90 cm; without the support, it is 85 cm. The support features two casters at the left and right side at the back; these facilitate moving the cooker. At the front, left and right, the support is fitted with adjustment screws that can be used to level the cooker horizontally and to level its upper edge flush with the furniture element standing next to it (if any). The adjustable feet are accessible, when the cooker drawer is removed; if required, they may be turned to increase or decrease the height, until the appliance is not in a completely horizontal position. The adjustment screws can easily be turned if the cooker is tilted slightly to redistribute the load. Additional support may also be removed by undoing the four screws from the lower side; these screws attach the support to the cooker side walls. In this case, remove the adjustment screws from the support and insert them left and right into the lower front cooker support panel. Level the cooker horizontally as described above. Some cookers are fitted with four adjustment screws at the lower part (two at the front and two at the back); these are intended for leveling uneven floor or for adjusting the cooker height to the level of the kitchen furniture elements installed next to the cooker.

## Protecting the appliance from tipping over

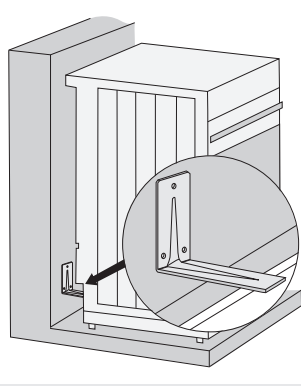

Figure 1

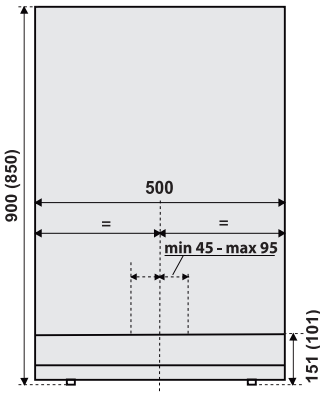

Figure 2

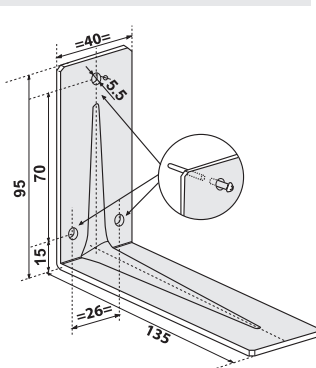

Figure 3

The appliance can be protected against tipping over using the supplied angle bracket.

Before installing, we recommend placing the appliance and levelling it according to your requirements using the adjustable feet (see chapter Levelling the Appliance and additional support).

Please refer to Figure 2, illustrating the appliance's built-in dimensions, with angle bracket installed and adjustable feet fully retracted.

Make sure the angle bracket is placed within the specified zone.

- Select the starting position for installation and push the appliance all the way to the wall.
- Pull out the appliance drawer.
- Use a pencil to mark the middle of the appliance on the wall, through the opening in the lower part of the appliance. Then, make another mark 45 to 95 millimetres to the right of the middle (Figure 2).
- Place the shorter end of the angle bracket against the mark on the wall. The longer end of the bracket should touch the upper surface of the profile at the back of the appliance (Figure 1).
- Through the holes in the lower part of the appliance, mark the centres of the three holes with diameter of 5.5 millimetres. These holes are located on the shorter end of the angle bracket pressed against the wall (Figure 3).
- Pull the appliance out of the starting position. Drill three holes at the marked spots and insert the supplied plastic wall plugs.
- Attach the bracket to the wall with the screws supplied.
- Push the appliance to the selected starting position and replace the drawer.

### NOTES:

- The measures in parenthesis are the built-in dimensions of the angle bracket without the additional support.
- If the screws and wall plugs supplied do not allow attaching the supplied bracket firmly to your wall to prevent the appliance from tipping over, use other fittings to attach the angle bracket in a way that will prevent it from being pulled out of the wall.

## Connection to the gas supply

### Factory settings

- Gas appliances are tested and fitted with the CE symbol.
- Gas appliances are delivered sealed; upon delivery, they are adjusted to the natural gas type H or E (20 mbar), or to liquid gas (50 or 30 mbar). The data is indicated on the rating plate located on the inner side of the oven; it is visible when oven door is opened.
- Load and gas consumption for particular burners are indicated in the table in these instructions.
- When the appliance is readjusted to another type of gas, the nozzles must also be replaced (see the section "Nozzle table").
- In case of repair, or if the seal is damaged, all functional parts must be tested and resealed in compliance with the installation instructions. Functional parts include the following: fixed nozzle for large flame and adjustable regulation valve / screw for small flame.

### Connection to the gas supply

- When connecting the appliance to the gas pipeline or gas cylinder, follow the regulations of the local gas distributor.
- On the right side, the cooking hob is fitted with a gas connection plug with an EN 10226-1 / -2 or EN ISO 228-1 (Depending on the country-specific connection regulations.) external thread.
- Also supplied with the appliance is an adapter for liquid gas and a non-metal gasket.
- When connecting, the knee R 1/2 should be held firmly to prevent it from rotating.
- For sealing of the connection joints, use a non-metal approved gaskets and approved sealants.
- The gaskets should only be used once. The thickness of the flat non-metal gaskets should not be deformed more than by 25 percent.
- To connect the appliance to the gas supply, use a tested and certified flexible hose. The hose should not be in direct contact with the appliance back wall or the oven ceiling.

 **After connecting the gas hob, check the joints for any leakages.**

### Connection with a flexible hose

- If an appliance is connected with a flexible hose, the hose should not be fed as indicated in the Figure A.
- If the connection pipe is made of metal, the option A is also permissible.

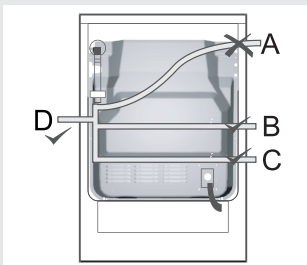

### Start of operation

When putting the appliance into operation, follow the instructions for use. Turn on all heaters and check the stability of the flame at high and low setting.

The flame should be blue and green at the center.

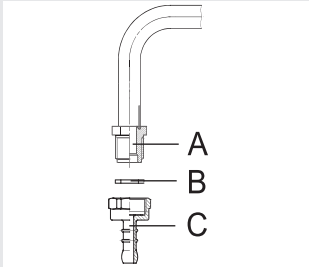

### Connection to the gas supply plug

- A** EN 10226-1 / -2 or EN ISO 228-1 (Depending on the country-specific connection regulations.) connection plug
- B** Non-metal gasket with thickness of 2 mm
- C** Pipe adapter for liquid gas (Depending on the country-specific connection regulations.)

After the connection, check the burners for correct operation.

The flames must be clearly visible, and should be blue and green at the center. If the flame is unstable, increase the minimum power. Explain the use of the burners to the user and read the instructions for use together.

### **Adaptation to a different type of gas**

- The procedure or adaptation of the cooker to another type of gas does not require removal of the appliance from the worktop.
- Before adapting, disconnect the appliance from the power mains and close the gas supply valve.
- Replace the existing nozzles for nominal thermal load with corresponding nozzles for the new gas type (see table below).
- When adapting the appliance to liquid gas, fasten the regulation screw for minimum thermal load as far as it will go, in order to attain minimum thermal load.
- When adapting the appliance to natural gas, release the minimum thermal load regulation screw in order to attain minimum thermal load, but do not rotate it by more than 1.5 turns.

**After the appliance has been adapted** to another type of gas, stick a new label with the new data on the appliance gas type adjustment (on the rating plate) over the old one, and check the appliance functionality and sealing. Make sure the electric conductors, capillary thermostats, and thermo-elements do not reach into the gas flow area.

## Adjustment elements

- Adjustment elements for minimum load of the burners are accessible through the openings in the control panel.
- Remove the support grid and burner covers with the crown.
- Remove the control knobs.

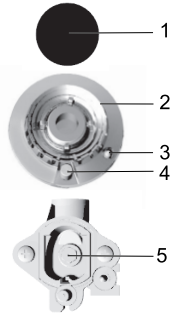

### Cooker burner (Figure 1)

- 1 Burner crown cover
- 2 Burner crown with cover support
- 3 Spark plug
- 4 Thermo-element (only in protected burners, only available in some models)
- 5 Nozzle

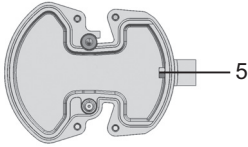

### Mini wok (Figure 2)

- 5 Nozzle

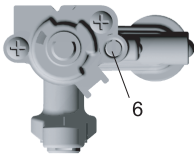

### Gas valve fitted with a protection device (Figure 3)

- 6 Nozzle



### Gas valve without a protection device (Figure 4)

- 6 Minimum thermal load regulation screw

Cooker burner	Figure / drawing number	Element code
Nominal thermal load	1,2	5
Minimal thermal load	3,4	6

## Electrical connection

The appliance may only be connected to the power mains by an authorized service technician or a registered electrician! Incorrect connection may result in damage to or destruction of respective parts of the appliance; in such cases, the warranty is void.

- Open the connection clip using a screwdriver, as indicated on the figure on the cover.
- The voltage (230V against N) in your home network must be checked by an expert using appropriate equipment!
- The connection bridges must be placed in compliance with the network connection!
- Before connection, make sure the voltage on the rating plate is consistent with the actual network voltage.
- The length of the power cord should be at least 1.5 meters; thus, the appliance can be connected before it is pushed to the wall.
- The length of the power cord should be adjusted in such way that in case of pulling load on the cable, the ground wire is strained later than the voltage wires.

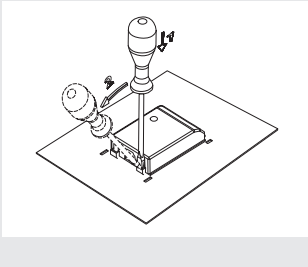

### Procedure

- Use a screwdriver to open the cover of the connection terminal on the back of the appliance. Release the two clips as indicated on the cover of the connection terminal.
- The mains cord must be inserted into the strain release device which protects the cable from being pulled out. If the strain release device is not installed yet, install it in such way that it gets stuck in the connection terminal housing at one end.
- Then, connect the appliance according to the instructions indicated on the figures. If network voltage is different, the connection bridges should be replaced.
- Firmly fasten the strain release device and close the cover.

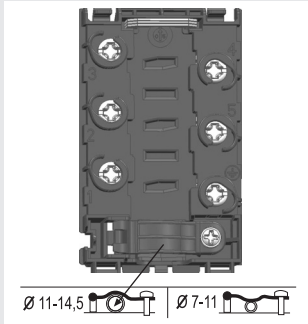

**NOTE:** Connection bridges are stored in the slots provided in the connection terminal. The connection screws are already open and do not require additional releasing. When fastening the screws, they will click, which indicates that the screw must be fastened all the way.



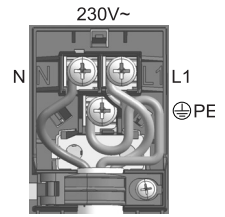
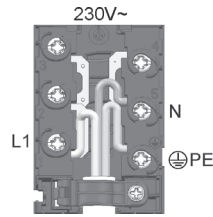
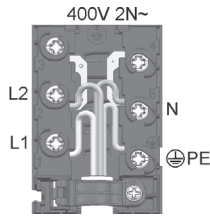
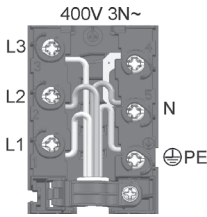

### Lead colors

L1, L2, L3 = external leads under voltage. Normally, the lead colors are black, black, brown.

N = neutral lead, normally blue.

Make sure the N-lead is connected correctly!

PE = protection, or earth (ground) lead, normally green-yellow.

## Nozzle table

gas type, pressure		Auxiliary burner				Normal burner		large burner	
		Standard		Quick		max	min	max	min
		max	min	max	min				
Natural gas H Wo=45,7+ 54,7 MJ/m <sup>3</sup> , Natural gas E, Natural gas E+ Wo=40,9+54,7 MJ/m <sup>3</sup> G20, p=20mbar	Nom. therm. load (kW)	1	0,36	1	0,36	1,90	0,46	3	0,76
	Consumption (l/h)	95,21	34,4	95,21	34,4	180,9	43,8	285,64	72,4
	Nozzle type (1/100mm)	77	-	78	-	104	-	129	-
	Nozzle code	162081		162082		162083		162084	
Liquid gas 3+, B/P Wo=72,9+87,3MJ/m <sup>3</sup> G30 p=30 mbar	Nom. therm. load (kW)	1	0,36	1	0,36	1,90	0,46	3	0,76
	Consumption (g/h)	71,7	26,2	71,7	26,2	138,1	33,4	215,0	55,3
	Nozzle type (1/100mm)	50	29/24	50	29/24	69	33/26	87	43/33
	Nozzle code	162162		162162		162164		162165	

Vrsta, pritisak plina	Wobejevo število	Mini Wok		Oven burner		Infra burner
		max	min	max	min	
Natural gas H Wo=45,7÷ 54,7 MJ/m <sup>3</sup> , Natural gas E, Natural gas E+ Wo=40,9÷54,7 MJ/m <sup>3</sup> G20, p=20mbar	Nom. therm. load (kW)	3,3	1,56	3,5	0,81	2,7
	Consumption (l/h)	314,2	148,5	339	77,1	259
	Nozzle type (1/100mm)	134	•	135	•	120
	Nozzle code	162086		609288		609287
Liquid gas 3+, B/P Wo=72,9÷87,3MJ/m <sup>3</sup> G30 p=30 mbar	Nom. therm. load (kW)	3,3	1,56	3,5	0,81	2,7
	Consumption (g/h)	239,9	113,4	250,9	58,9	193,5
	Nozzle type (1/100mm)	91	57/57	90	42/42	81
	Nozzle code	162167		609290		609289

- Regulation valves that are factory-built-in are intended for liquid gas; however, the valves are set for operation with the type of gas for which the appliance is factory-preset.
- When adapting the appliance for use with another type of gas, the regulation screw (valve) should be fastened or release to correspond with the required gas flow / throughput (however, the regulation screw should not be released more than by 1.5 rounds from the position in which it is completely fastened).

Burner power is indicated by observing the upper Hs calorific value.

**Warning: these tasks may only be carried out by a qualified technician, authorized by the gas distributing company or authorized service center!**

# Technical characteristics

## Rating plate

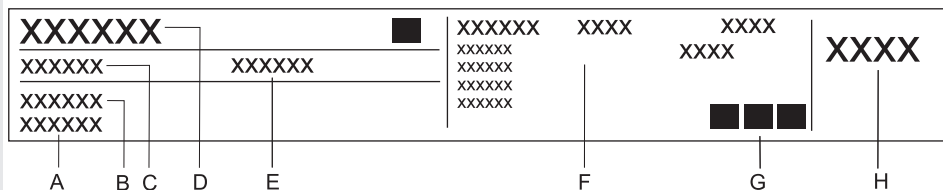

- A** Serial number
- B** Model
- C** Type
- D** Trademark
- E** Code
- F** Technical information
- G** Compliance indications / symbols
- H** Factory settings for gas type

WE RESERVE THE RIGHT TO MAKE ANY CHANGES THAT DO NOT AFFECT THE FUNCTIONALITY OF THE APPLIANCE.

Instructions for use of the appliance can also be found on our website at [www.gorenje.com](http://www.gorenje.com) / < <http://www.gorenje.com> / >

