

A transdisciplinary approach to understand, compute and visualize the city interface

S. Coccolo, J. Gong, A. Kostro, D. Mauree, A.T.D. Perera, A. Schueler, J.-L. Scartezzini

INTRODUCTION

Urban world, affects our **health and wellbeing**

Infinite microclimates within a city: geometry, thermal properties of the urban surfaces

City interface plays a major role: energy demand, systems and thermal comfort

Comprehensive view of the **energy fluxes**: quantify and analyse the city behaviours

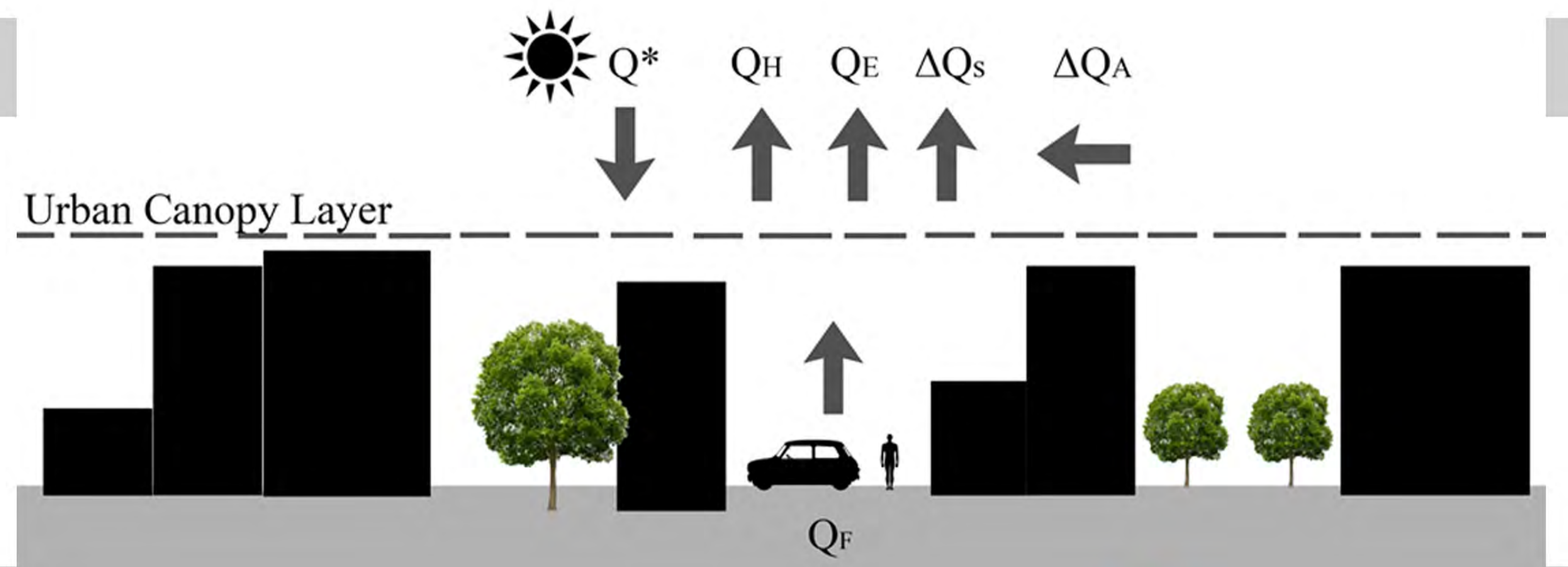

INTER- and TRANSDISCIPLINARITY



CITY INTERFACE:
The point where two or more systems, within the urban texture, meet and interact each others

Radiative environment
Direct shortwave radiation
Shortwave radiation diffused by the sky
Shortwave radiation reflected
Longwave radiation

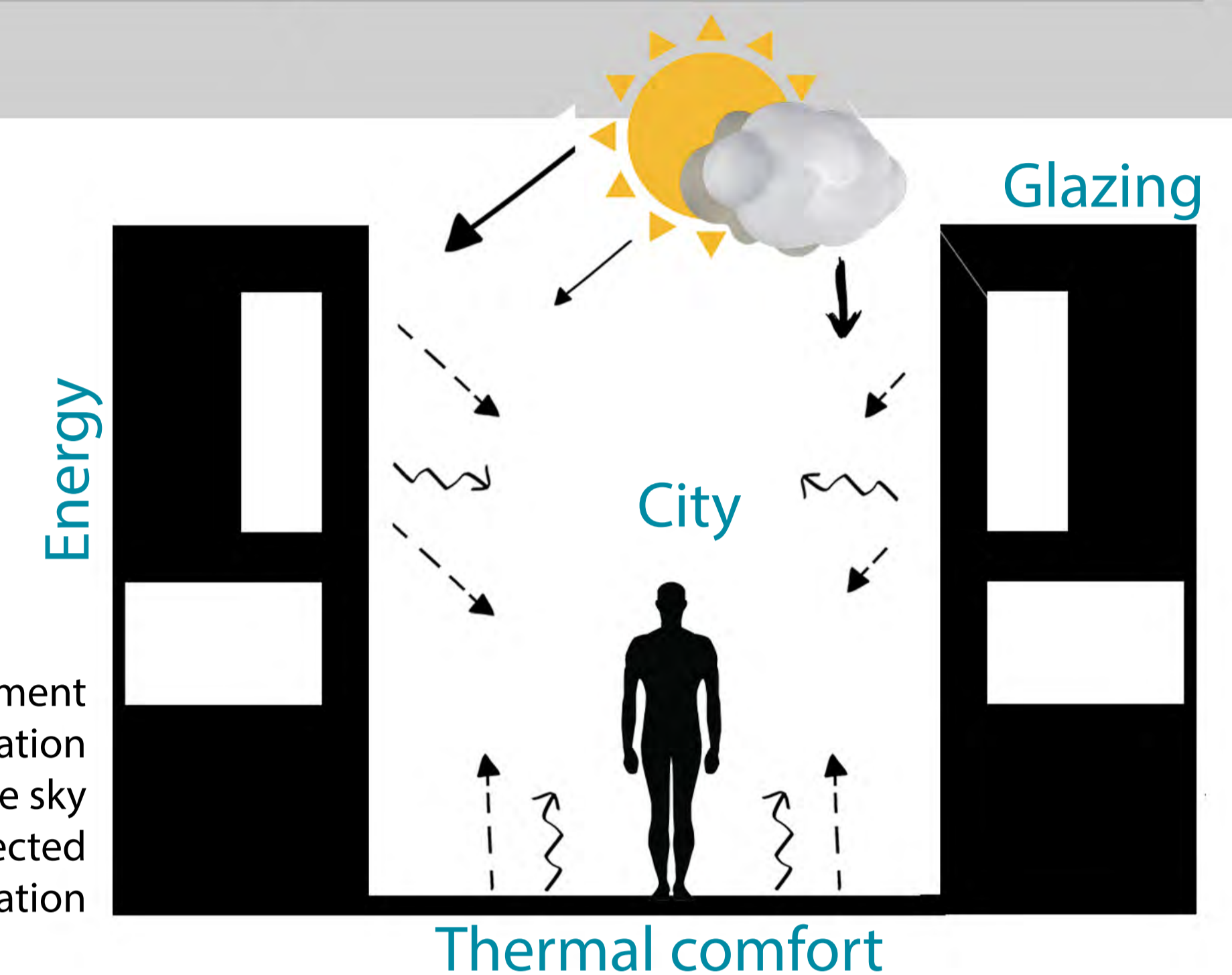

METHODOLOGY

URBAN CANYON CONFIGURATIONS

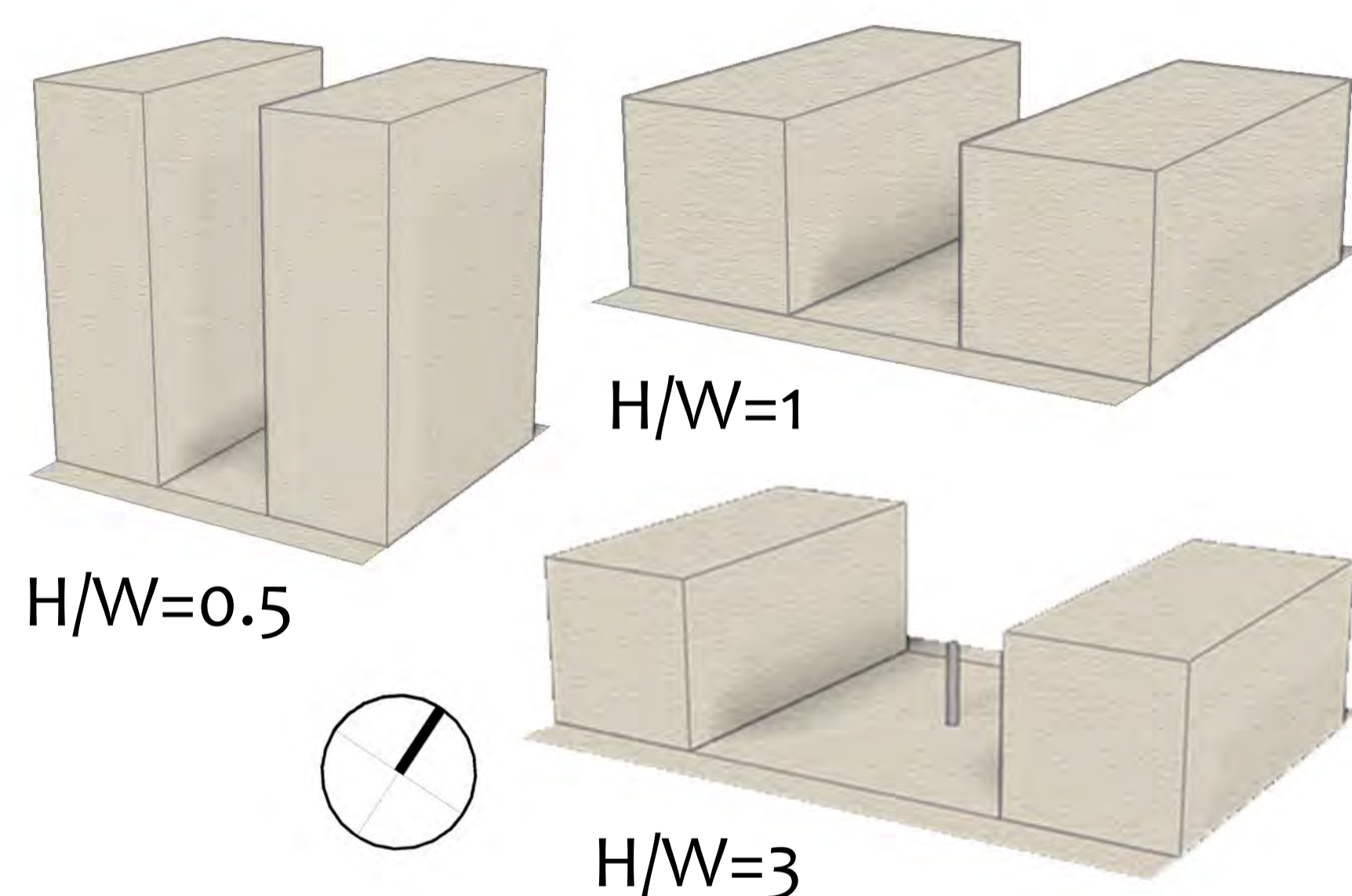

Climatic Data: **Lausanne** (Switzerland) and **Dubai** (UAE)

Glazing percentage, specular and diffuse reflectivity

THERMAL COMFORT DYNAMIC MODELLING

COMFA* budget_ Thermal comfort

$$B = M_h + R_{RT} - C - E_{s+i} - L_s$$

Mean Radiant Temperature_ Microclimate

$$T_{mrt} = \sqrt[4]{\left(\frac{S_{str}}{\epsilon_p \sigma}\right)}$$

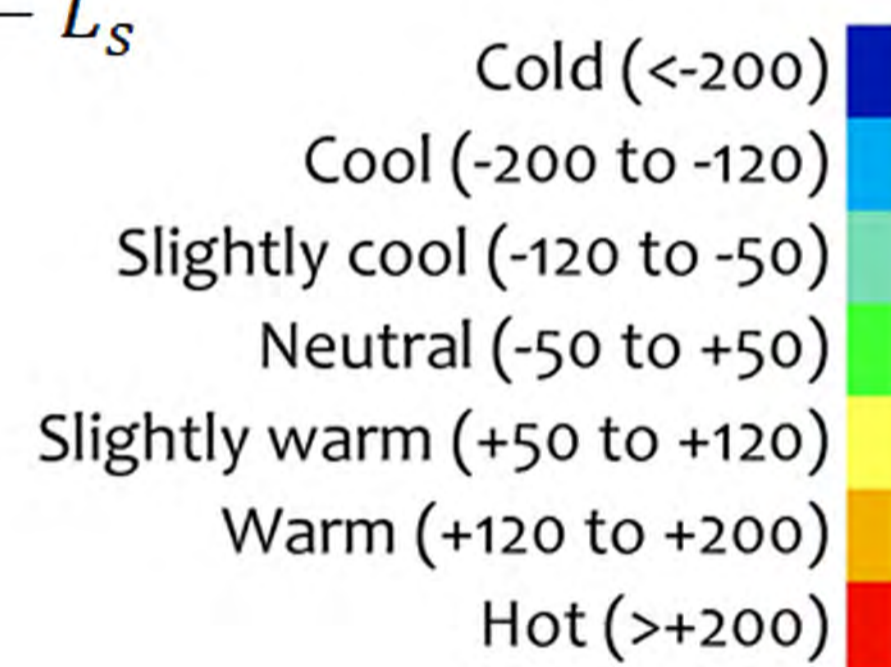

ADVANCED GLAZING SYSTEM

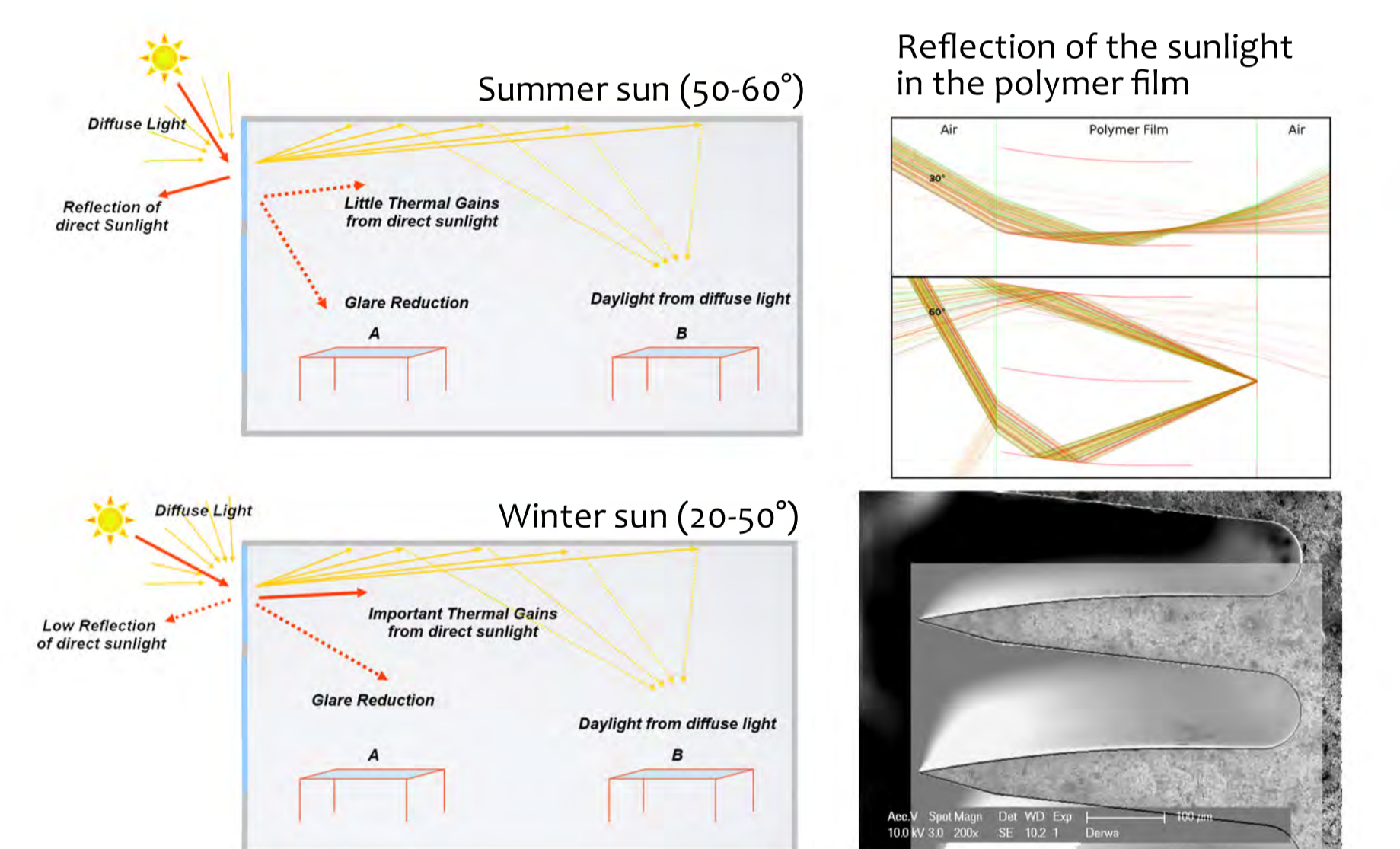

Laser cut micro-mirrors to improve **lighting** and **visual comfort** inside buildings

Autonomous system integrated in the windows

RESULTS AND DISCUSSION

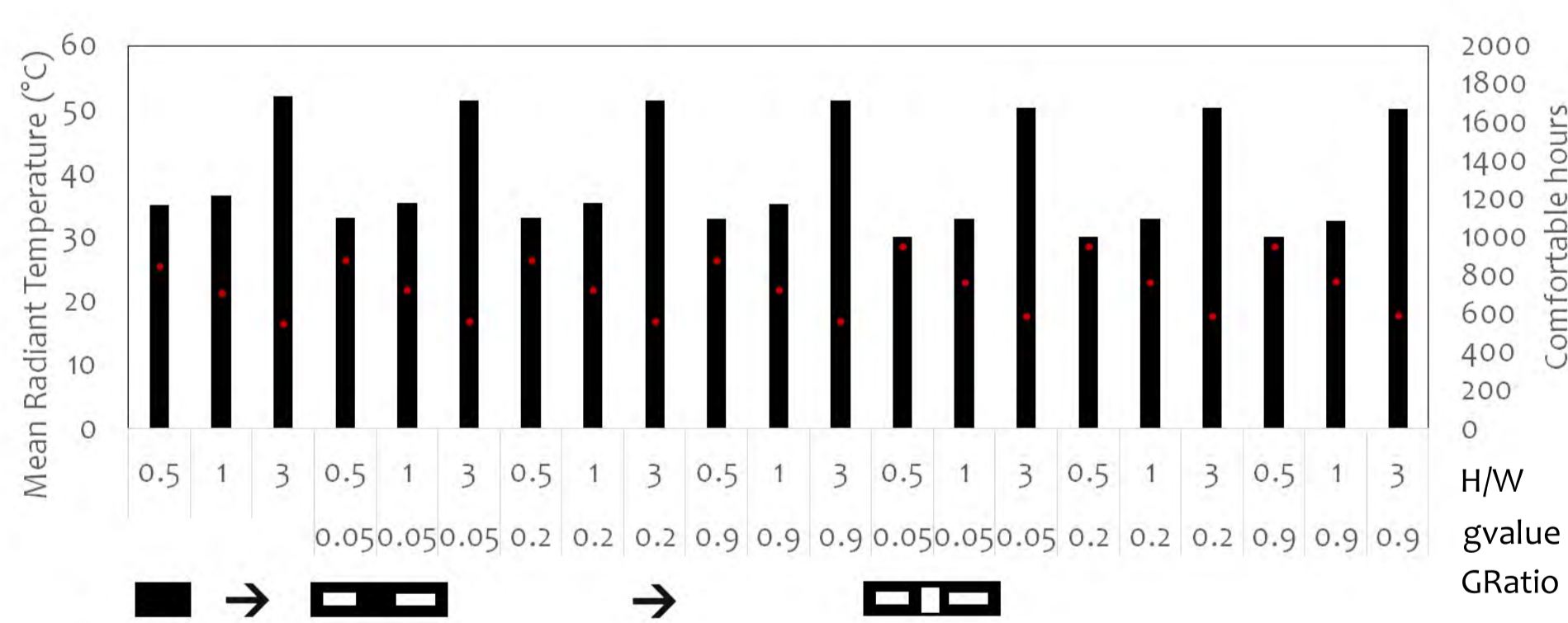

Max CoH: 1718 hours
GRatio: 0.2

Min CoH: 1004 hours
GRatio: 0.7

Heating demand: 20%
Lausanne

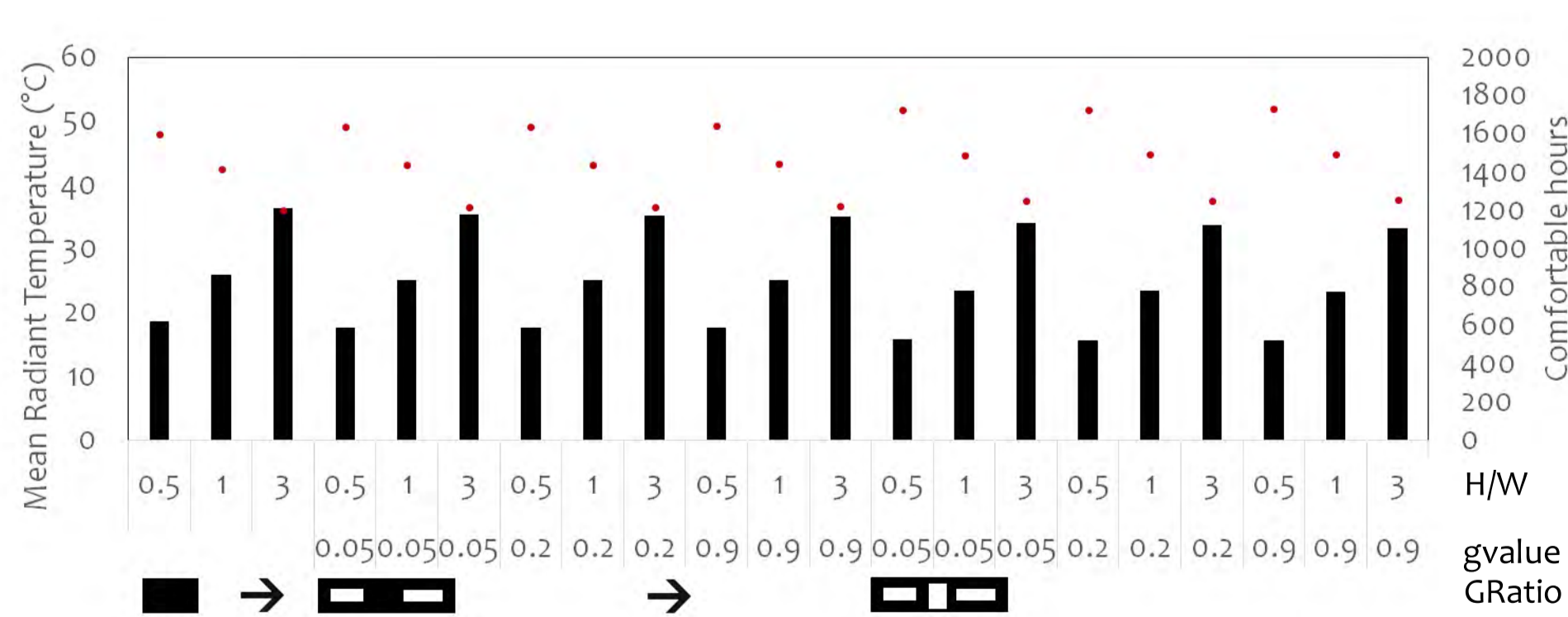

Max MRT: 51.9°C
Min CoH: 522 hours
GRatio: 0.7

Min MRT: 36.5°C
Max CoH: 1177 hours
GRatio: 0.2

Cooling demand: 50%
Dubai

Daytime analysis (8:00-18:00 hours)
Major role **urban configuration** and **glazing ratio**
Impact on the **radiative environment** and the **energy demand** of buildings

Average MRT from 0.2 to 0.7 glazing ratio:
+3.2°C daytime (annually) and **+4.1°C** during summer season

HUMAN ENERGY BALANCE

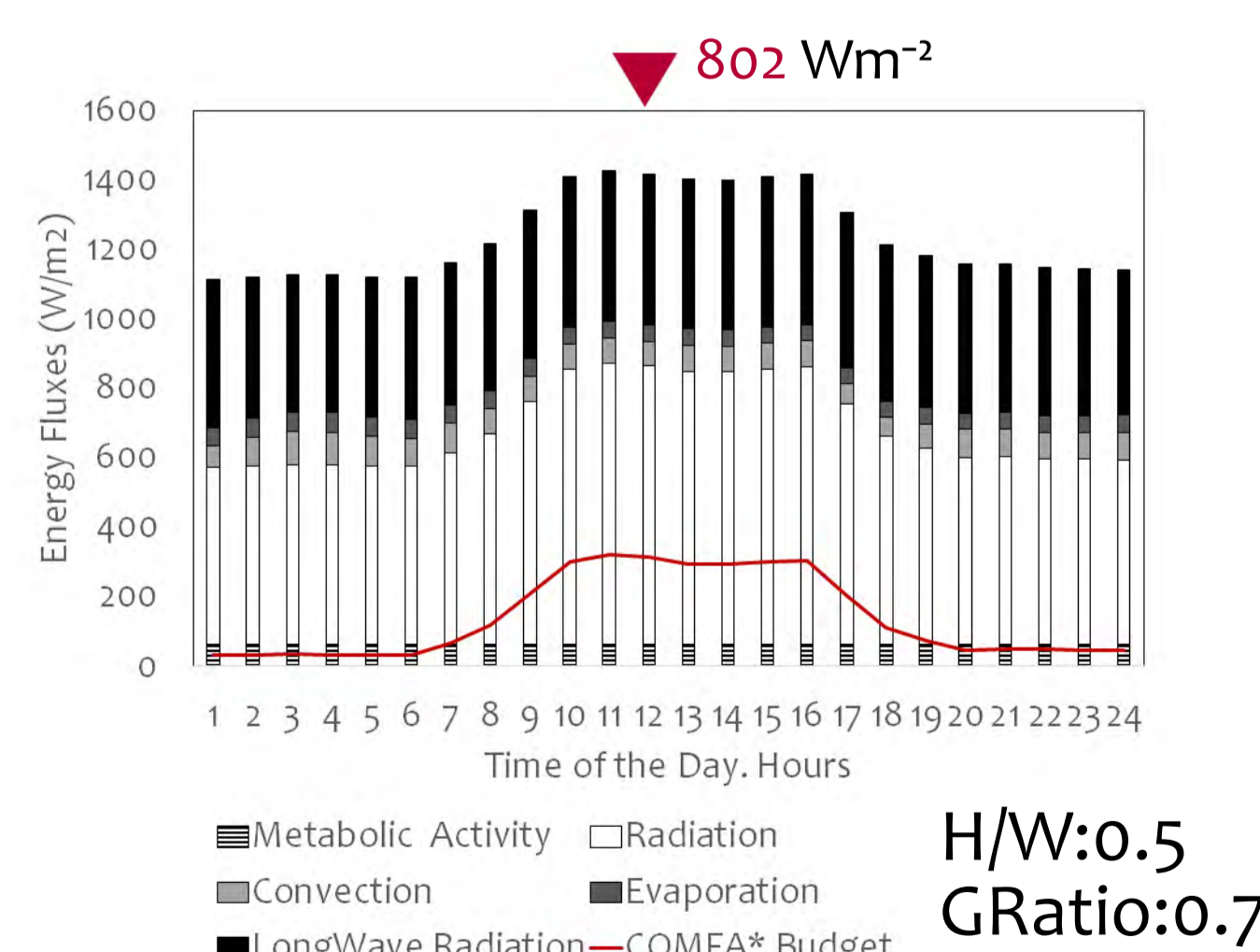

During summer season: **+26 W/m²**

Advanced glazing system:
strong **up-warded reflection** in summer
reducing the radiation reflected to the pedestrians

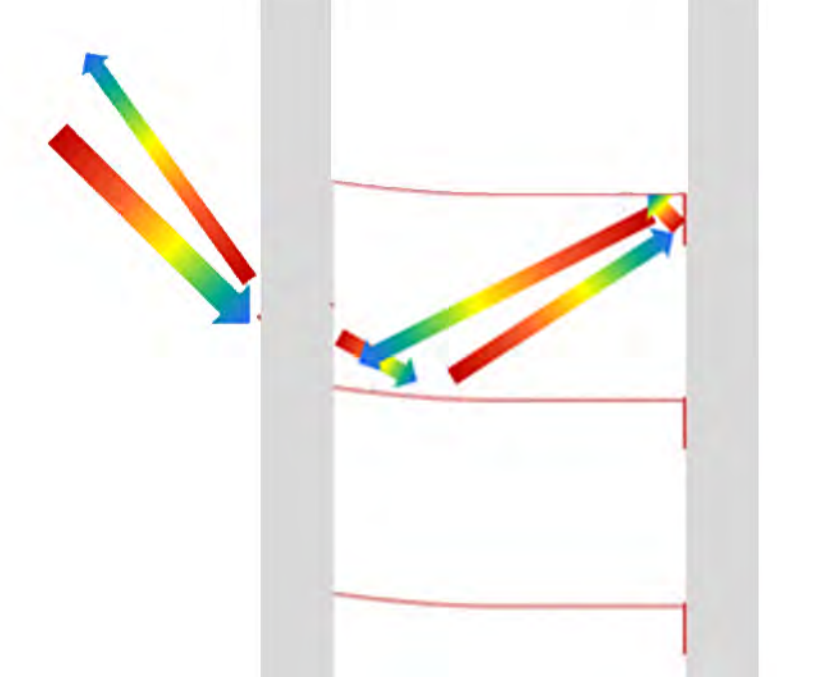

CONCLUSIONS

Climatic dependent design.

Major role **urban configuration**, **materials** and **glazing ratio**.

Advanced glazing system nicely improve outdoor environmental conditions by reducing the **extremes**, "warm" events, providing seasonal **indoor thermal control**, **daylighting**, **glare** protection and **visual comfort**.

Urban features have a strong impact on the **radiative environment**, on the **microclimatic** urban conditions, as well as on the **energy demand** of buildings (20% heating and 50% cooling demand) and **energy systems** (hourly peak demand).

J. Y. Suk, M. Schiler, and K. Kensek, "Reflectivity and specularity of building envelopes: how materiality in architecture affects human visual comfort," *Archit. Sci. Rev.*, vol. 60, no. 4, pp. 256-265, 2017.

A. T. D. Perera, S. Coccolo, J. L. Scartezzini, and D. Mauree, "Quantifying the impact of urban climate by extending the boundaries of urban energy system modeling," *Appl. Energy*, vol. 222, no. April, pp. 847-860, 2018.

J. Gong, A. Kostro, A. Motamed, and A. Schueler, "Potential advantages of a multifunctional complex fenestration system with embedded micro-mirrors in daylighting," *Sol. Energy*, vol. 139, pp. 412-425, Dec. 2016.